

# Cruising Equipment Co.

NEW!

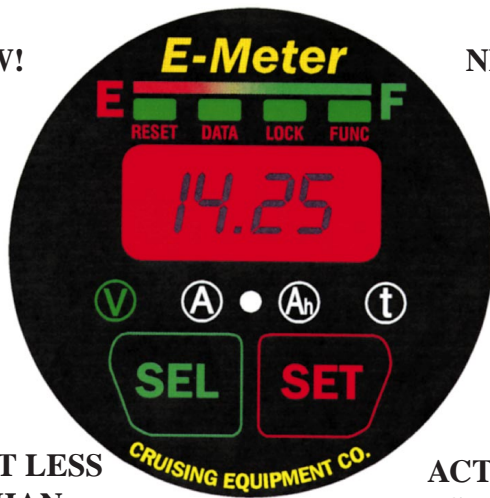

NEW!

COST LESS  
THAN  
\$200

ACTUAL  
SIZE!!

**“World Leader in  
State of Charge Instrumentation”™**

Cruising Equipment proudly introduces the **E-Meter** the smallest, most powerful, and easiest to use battery state of charge instrument ever created! Look at these features!

- **Digital Display:**

Volts, Amps charging or consumption, Amp-Hours consumed, and Time Remaining. Time remaining based on your choice of present consumption, average consumption during the last 6 minutes, 30 minutes, or the last 24 hours.

- **Graphical Display:**

Four multi color LEDs for “at a glance” battery capacity remaining. Indication of low battery and that the battery has reached the charged parameters.

- **Historical Data:**

DATA mode displays four critical battery performance indicators; Charging Efficiency, Number of Cycles, Average Depth of Discharge, and Deepest Discharge.

- **Powerful Options:**

RS-232 output for computer interface. Relay output for charge control or automatic generator starting. Temperature sensing for battery capacity compensation.

- **Versatile:**

One model fits all! All important variables adjustable from front panel. Mounts in standard 2” dia. hole. Only 2.7” deep. Power supply 8 to 40 Volts. Voltage range 0–50V or 0–500V selectable from front panel.

## Cruising Equipment Co.

6315 Seaview Ave. NW Seattle, WA 98107  
FAX (206) 782-4336 Phone (206) 782-8100

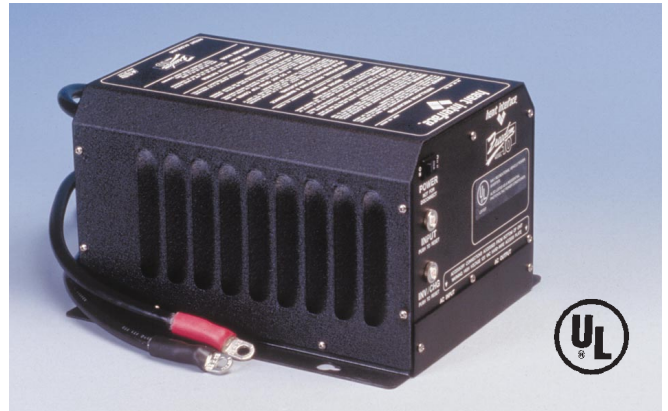

### World Leader in Back Up Power

Heart Interface pioneered the ultra-high efficiency power inverter and now offers worldwide distribution of a complete line of inverters and inverterchargers. Most models are in stock and available for immediate delivery.

- \* Models from 600–2500 watts
- \* Charging Rates from 25–130 amps
- \* Full line of 230 volt, 50 HZ Models Available
- \* Phase Synchronized Transfer Switching
- \* 12 Models with UL Listing for Residential Solar
- \* High Efficiency Throughout Power Range

Heart Interface’s modern 72,000 sq. ft. facility features complete transformer and circuit board manufacturing capabilities as well as fully integrated assembly lines and automated test center. All Heart inverters are backed by its industry leading 30 month warranty and unparalleled customer support.



21440 68th Ave. So. Kent, WA 98032  
Phone (800) 446-6180 or (206) 872-7225  
FAX (206) 872-3412

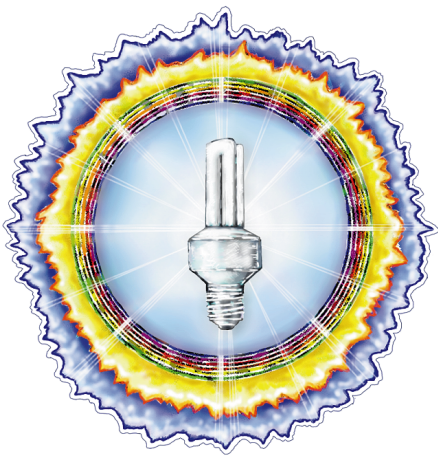

# HOME POWER

THE HANDS-ON JOURNAL OF HOME-MADE POWER

Issue #49

October / November 1995

## Features



- 6 Jane Goes Solar**  
*Jane Sharp of downtown Chapel Hill, North Carolina powers a portion of her home on solar electricity. Solar Energy International students and local businesses help Jane fulfill her dream of clean, non-nuclear power!*



- 14 Solar-Powered Paradise**  
*Andrew Terker and Beatrix Pfeleiderer built a photovoltaic-powered home on the Big Island of Hawaii. They use solar energy and permaculture to change lava beds to paradise.*



- 22 MREF 1995**  
*A photo scrapbook of this year's Midwest Renewable Energy Fair in Amherst, Wisconsin. For five years running, MREF is best in the nation.*

## GoPower



- 50 Future, Present, and Past**  
*Michael Hackleman talks about his upcoming book, the lead-acid controversy, and the US electric vehicle population.*
- 52 Electric Autorickshaws**  
*Jose Baer tells of electric rickshaws in Kathmandu, Nepal.*

- 58 Sojourns with Shawk**  
*Michael Hackleman drives an electric motorcycle on Agate Flat's back roads.*
- 62 Wild Cat One**  
*Clare Bell continues with design and construction of a shopping cart racer.*
- 68 Driving an Electric Car**  
*Shari Prange discusses driving tactics that extend the range of electric vehicles. Get more miles from less charge!*

## Fundamentals

- 28 PV Performance Tests**  
*Richard Perez and Bob-O Schultze conduct hot weather tests on ten different models of photovoltaic modules. See how well these PV modules perform after five years in the sun!*
- 43 Solar Hydronic Heating**  
*The Gimme Shelter Crew discuss solar hydronic heating systems, complete with summer time shunt loads.*
- 72 A Visit to a Battery Factory**  
*Steve McCrea takes us on a visit through a lead-acid battery factory. Also Richard Komp discusses the Carnegie Mellon "Lead Herring."*

Cover: Jane Sharp and the students of Solar Energy International put her Chapel Hill, NC home on solar power.

## Features

### 36 Renewable Energy—Kiwi Style

*Bill and Katcha Sanderson visit RE systems in New Zealand. Visit wind, microhydro, and photovoltaic systems in the land down under.*

### 40 Pleasing the Neighbors

*William Gerosa, Jr. AA2TS in Terrytown, NY installed a PV system for his ham radio shack. Solar-powered, reliable, radios and lights for under \$650!*

## Things that Work!

### 76 Hughes/RCA Digital Satellite System

*John Wiles tests this satellite TV system with 18 inch minidish. This is the entertainment answer for remote sites. Works great on inverters, too!*

## Columns

### 82 Independent Power Providers

*Don Lowebug and Bob-O Schultze tell about the recent REDI Conference in Willits, CA. Also info on California Senate Bill 656—Net billing for utility intertied PV systems*

### 86 Code Corner

*John Wiles discusses the 1996 cable and wire updates for the National Electric Code. Major changes make wiring easier for RE systems.*

### 89 Power Politics

*Michael Welch provides an update on rate-based renewable energy incentives. Davis, CA is thinking about paying more for PV power! Also info on energy budget cutting by the Feds for atomic fusion.*

### 92 Home & Heart

*Water, windows, mudrooms, grapevines, and the Smiling Buddha. It's all connected....*

### 98 the Wizard Speaks...

*Transmutation*

## Regulars

### 4 From Us to You

### 80 HP's Subscription form

### 81 Home Power's Biz Page

### 94 Happenings — RE events

### 100 Letters to Home Power

### 107 Q&A

### 109 Micro Ads

### 112 Index to Advertisers

## Access and Info

### Access Data

Home Power Magazine  
PO Box 520, Ashland, OR 97520  
USA

Editorial and Advertising:

916-475-3179 voice and FAX

Subscriptions and Back Issues:

800-707-6585 VISA / MC

Computer BBS: 707-822-8640

### Paper and Ink Data

Cover paper is 50% recycled (10% postconsumer and 40% preconsumer) Recovery Gloss from S.D. Warren Paper Company.

Interior paper is recycled (30% postconsumer) Pentair PC-30 Gloss Chlorine Free from Niagara of Wisconsin Paper Corp.

Printed using low VOC vegetable based inks.

### Printed by

St. Croix Press, Inc.,  
New Richmond, Wisconsin

### Legal

Home Power (ISSN 1050-2416) is published bi-monthly for \$22.50 per year at P.O. Box 520, Ashland, OR 97520. International surface subscription for \$30 U.S. Second class postage paid at Ashland, OR and at additional mailing offices. POSTMASTER send address corrections to Home Power, P.O. Box 520, Ashland, OR 97520.

Copyright ©1995 Home Power, Inc.

All rights reserved. Contents may not be reprinted or otherwise reproduced without written permission.

While *Home Power Magazine* strives for clarity and accuracy, we assume no responsibility or liability for the usage of this information.



Recycled Paper



Recyclable Paper



Photo by Robert Hale in Hawaii

## Chasing Rainbows

Two years ago, we discussed utility intertie of independently produced PV power at REDI in Willits, California. The concept was that anyone could become an energy farmer—selling their PV electricity back to the local utility at a reasonable rate. The consensus of the many California PV people at REDI was that we were chasing rainbows.

The major topic of discussion at this year's REDI conference was the passage of California Senate Bill 656. This bill mandates net billing for independent PV systems who place their power back on the grid. Here is a rainbow we chased and found.

To be sure, SB 656 is far from ideal. It excludes wind and microhydro systems for example. The net billing is net billing to parity, not the straight across net billing of all power as happens in states like Wisconsin. The size of the individual PV system is limited to 10 kW peak. But two years ago we thought even this was impossible to attain.

We should keep chasing rainbows. Every once in a awhile we even catch one.

Richard Perez for the Home Power Crew



## People

Jose Baer  
Clare Bell  
Lynne Allen Carter  
Sam Coleman  
William A. Gerosa, Jr.  
Michael Hackleman  
Kathleen Jarschke-Schultze  
Mark Klein  
Stan Krute  
Don Lowebug  
Harry Martin  
Steve McCrea  
James McKnight  
Don Monkerud  
Karen Perez  
Richard Perez  
Shari Prange  
Ray Reser  
Katcha Sanderson  
Dave Shantz  
Michael Welch  
John Wiles

## “Think about it...”

*“It is no use walking  
anywhere to preach  
unless our walking is  
our preaching.”*

St. Francis of Assisi

SOLAR DEPOT

FULL PAGE  
four color  
on negatives

this is page 5



Above: The Solar Energy International class and Jane Sharp in front of Jane's new photovoltaic array.

## ***Jane Goes Solar***

Lynne Allen Carter

©1995 Lynne Allen Carter

**O**n the day before Earth Day '95, thirty students arrived at the home of Jane Sharp in a residential area of downtown Chapel Hill, North Carolina. By afternoon of the next day, with the help of savvy friends and technicians, she was plugged into the sun. A solar-powered system had been installed that would run her lights, a ceiling fan, a television and radio, an answering machine, and her typewriter. Thirty students had walked away with a

valuable experience — the installation of a PV system. A system that will work almost anywhere on the planet.

Following her visit with Amory Lovins in 1985, Jane Sharp wasted no time in starting her solar quest. When she retired, she used the money from her social security payments to buy low-energy light bulbs, reselling them at cost at street fairs. "Anything we do is helping," she explains. "The more we do, the sooner we can get off the nuclear track." Watching her unload lights out of her Geo Metro is a common sight at area events.

Jane also opens her home office to non-profit organizations. It's not unusual for a lawyer or an activist

to stop by for last-minute photocopying before carpooling to a Senate hearing. Altogether, Jane is a supportive, loving grandmother who fights for her beliefs.

The project to outfit Jane's home with solar power was a natural coalescence of many forces at work in close proximity to each other.

First, Johnny Weiss of SEI (Solar Energy International, Carbondale, CO) wanted to do a week-long PV (photovoltaic) class in Raleigh, North Carolina. Following four days of instruction, he wanted the class to "graduate" by actually installing a *real* system in the area. Next, Joe Flake of Go Solar Enterprises, in a meeting at the Solar Center (the energy section of a department of the NC Department of Commerce) mentioned that SEI needed a PV system installation to use as part of a class project. Jane Sharp was in Joe Flake's audience at the Solar Center. She stood up and offered her home for the class-built PV system.

### The Project Begins

Jane Sharp hired Chris Carter and Jacques Menache of the Solar Village Institute, Inc. to contract the installation and coordinate it with the class. Joe Flake proved invaluable here by planning the visit from SEI to NC. He pulled together the classroom and facilities, arranged accommodations, provided meals—all with warm North Carolina hospitality. Jane was thrilled with the whole idea. She would get PV for her home and an entire class could learn from the installation, too.

My part, was completing a circle to work with Johnny Weiss on this level. I've taken classes from him over the last five years at SEI in Carbondale, Colorado. I like SEI because, in organizing classes around the world, they are sending a message of sustainability and hope to people of all races and backgrounds. There were students from Africa, Canada, and Germany working on Jane's installation.

I can recall one moment when Johnny asked Jane during a class, "Why would you put solar on your house? You will never pay for it in your lifetime." Jane's response was clear and vital. "I believe in solar. We must start using solar now. No more nuclear power plants. We must support technologies for *sustainable* energy. And I want to be a part of the solar revolution."

### Siting the Solar Array

The roof of Jane's home was not the ideal site for a PV array. It was already crowded with solar hot water collectors and sky lights, limiting the space available for PV panels. Several large evergreens directly south of the house complicated the issue. Using the solar Pathfinder at this point was *crucial* in the design of the



Above: Jane Sharp checks out the owner's manual for her new Trace 2424 inverter.



Above: Chris Carter of Solar Village Institute teaches the class how to properly mount and wire the photovoltaic array. Since PVs will easily produce power for over ten years, details such as module wiring are critical if the array is operate for ten years without problems.

# Jane Sharp's PV/Utility System

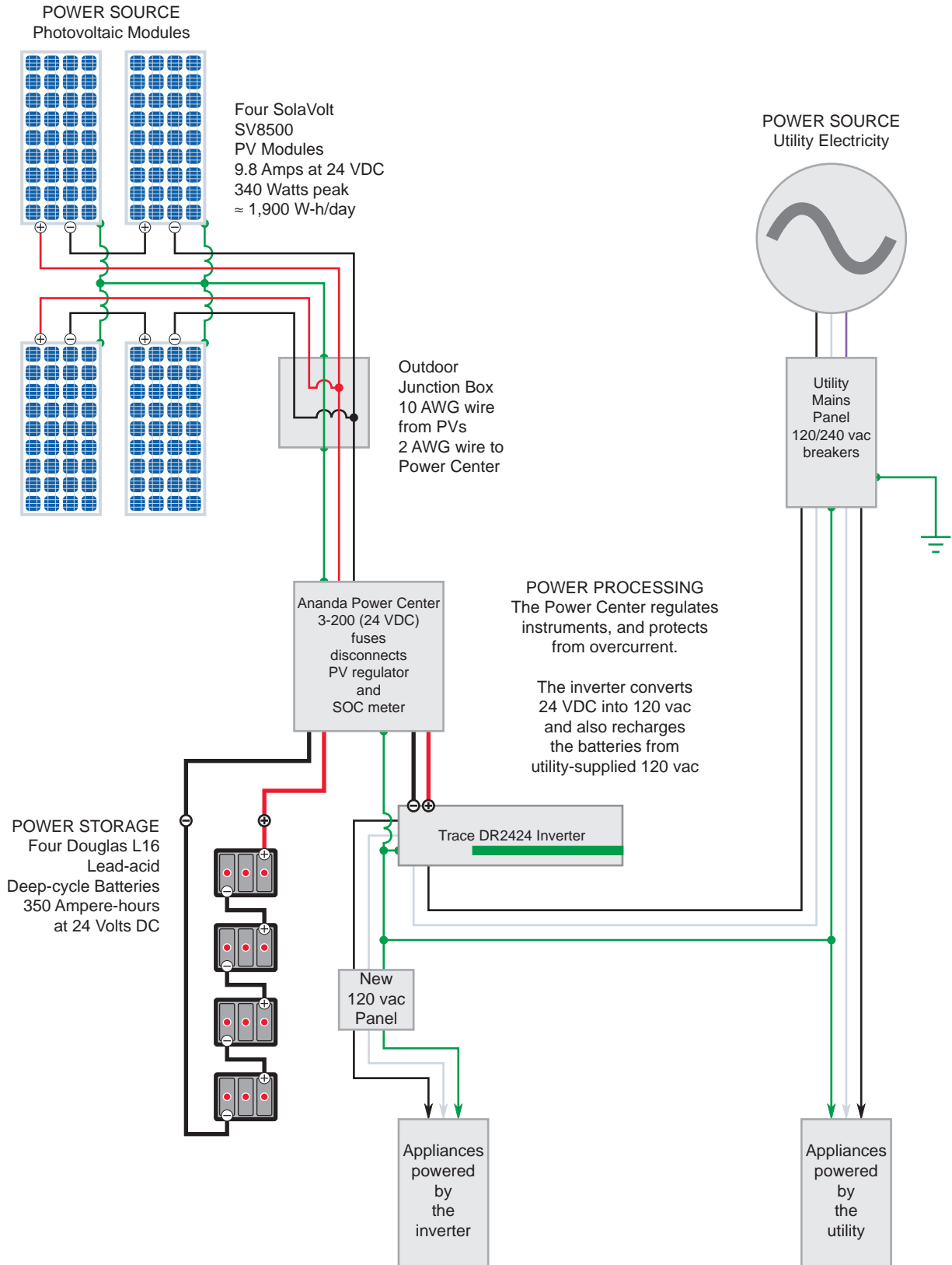





Above: Chris Carter shows students how to operate a Solar Pathfinder. The Solar Pathfinder is *the* tool for finding the best location for photovoltaic arrays and solar heat collectors.



Above: Johnny Weiss of Solar Energy International (SEI) has done scores of PV installations and classes.



Above: The Ananda Power Center, the Trace inverter, and the vented battery box (with the yellow sun). All these components are safely and neatly installed in Jane's basement



Above: Joe Flake of Go Solar Enterprises runs PV cables through Jane's attic. It is often small matters such as wiring that are critical and difficult. The hands-on training offered by SEI in their on-the-job courses gives their students experience in details such as safe and standard wiring practices. Classroom training is fine and necessary, but it must be backed-up with actual installation experience.

## Systems

### Jane Sharp's PV-powered Appliances

#	Appliance	Run Watts	Hours/Day	Days/Week	W-hrs/Day
1	Television Set	192	2	7	384
1	Ceiling Fan	58	6	7	348
1	Kitchen Light	38	6	7	228
1	Fan	96	4	3	165
1	Ceiling Light	23	7	7	161
1	Radio/Tape player	13	10	6	111
3	Living Room Lights	15	2	7	90
2	Outdoor Lights	17	1	7	34
1	Table Light	17	1	7	17
1	Porch Light	15	1	7	15
1	Typewriter	42	1	1	6
<i>Watt-hours per Day</i>					1559

system. For example, it showed that the best solar window (only three hours) was just over the front porch on the north side of the roof. A shade-resistant, high-voltage PV module appeared the best choice, so we chose SolaVolt's 8500 module. The photovoltaic cells in this module are individually protected against the effects of partial shading on the module.

The abundance of trees around the house warranted the use of a pole to get the PV modules clear of roof and tree shadows. With four feet in the ground and nine feet to the eaves, a 20-foot pole would extend the modules seven feet above the roof. Just right! A 2-inch galvanized, Sch#40 pipe was purchased from the local plumbing supply. (A mistake! This is too small a diameter, and later required extra bracing from the roof.) Some slits were cut on bottom of the pipe, then flared out. A bracket bolted to the eave was installed to hold the pipe away from the gutter. A 4-foot hole was dug and the pipe set. Three bags of concrete were poured around the base and troweled, and the concrete left to cure.

The top of the pole mount was the last piece of equipment to arrive—the day before the project started! We were shocked to discover it was designed for a three-inch pipe. This was not what we had expected. Our two-inch pole was already in the ground. This could be a big disappointment for the class!

Chris got on the phone to Mark at Photocomm and explained the emergency! Mark said he would send out a replacement overnight. Amazing! And it really happened. The next day (Friday), it was delivered to the site. WOW! I thought. Mark said "Its my job."

### Battery Storage and Control System

The electrical distribution system was located in the basement. There was plenty of room for the system's batteries, inverter, power center, and the new solar distribution box. Still, the space was crammed with 35 years' worth of hardware and debris belonging to Jane's late husband, Gordon Sharp, a physicist and inventor. There were several milling machines, lathes, saws, and even a high speed centrifuge. Jane sold the big tools to raise money for her solar-electric system. Eventually, Chris and Jacques removed all the old and unusual wiring in the basement and shoveled piles away until there was adequate workshop space.

#### Day One: The Class Arrives

The class moved from Raleigh on Friday morning to Jane Sharp's home in Chapel Hill. They jumped right into the project. They unreeled 75 ft. of #2 copper wire from the combiner and threaded it through conduit in the attic space to its end in the basement. Drilling the ceiling plate was more like drilling for oil by hand. Cramped in a hot and humid attic, Joe Flake drilled away. The class focused on placing a four-foot square of 3/8-inch plywood on the concrete block wall. It was painted blue to match the existing shop trim. The Trace DR 24-24 inverter was bolted on this plywood.

"Drilled!", Joe Flake's voice came from the attic. Six people were involved in pulling the line through the wall. Some very creative minds worked to fish a line through, repeatedly without success, because the wall was already filled with conduits and pipes. So, we abandoned this plan and pursued another. Plan B brought the #2 copper array wire back out to the exterior of the house, threaded through more of the

### Jane Sharp's PV System Cost

#	Component	Cost	%
4	SolaVolt SV8500 PV Modules	\$2,396	38%
1	Trace DR2424 Inverter	\$1,175	19%
1	Ananda APT3-200 Power Center	\$1,102	18%
4	Douglas L16 Batteries	\$520	8%
	Electrical Parts and Wire	\$303	5%
	Labor	\$240	4%
1	Zomeworks Pole PV Mount	\$199	3%
1	Outdoor Wiring Box	\$150	2%
	Steel Pole and Concrete	\$91	1%
	Lumber and Plywood	\$42	1%
	Shipping	\$34	1%

*Total cost* \$6,252



Above left: Johnny Weiss explains the innards of the Ananda Power Center.



Above center: Students wire a new electrical panel for the inverter.

Above right: Raising the PV array to Jane's roof is a job for many hands.



exterior conduit. The re-routed wire made it down the wall and back into the basement with only *inches* of wire to spare.

One highlight of the day was bolting the SolaVolt 8500 PV modules to the frame and wiring them together. All participants in the project wired and rewired them together to ensure a direct experience of this part of the process. Small connectors were crimped to the ends of the wires that interconnected the modules. There are several connection points inside the junction box on the back side of the panel: a positive, a negative, and two user-programmable jumpers.

The class finished up its first day by constructing the battery box and sanding it. The students had been hard at work and were ready for break time. Chris grabbed the two pole mounts and took them home. The shipped part still had to be mated to the existing pole. While we live off of the grid, we have a small welding shop in our art studio. Chris cut the two mounts apart, put the 3-inch top on the 2-inch bottom, and welded them together with a 24 V portable MIG. The rough edges were ground, rust-proof paint was applied and presto! A new top-of-pole mount.

### Day Two: The Project Continues

Saturday morning. Chris was up early, loading batteries into the truck and leaving for Jane's home. Jacques was already there, finishing up the conduit down the outside of the building

The students still had plenty of work to do. They wired together the Ananda power center (or APT, a 200-amp,



Above: Tom Phillips and Chris Carter discuss the installation of components in the basement. One major lesson in every PV installation is *plan ahead!*

two-pole disconnect) and the Trace DR 2424 inverter using 4/0 welding cable. The APT acts *both* as the charge controller *and* as the junction box for the PV input. It feels convenient and user friendly. Wires from the APT lead directly to the Trace.

The Trace inverter converts 24 Volt DC battery power to 120 vac. It also has a built-in battery charger. This helps back up the system, allowing grid power to recharge the batteries. For Jane, it also means that she can have lots of power if she needs it, for vacuuming or other heavy loads. Small controls on the front of the Trace are designed to help tune the setting of battery charge levels, and adjust the inverter's sensitivity to loads so it "sleeps" when no power is being used.

### It's Done

The rest of the installation went very smoothly and the final project looked wonderful. The battery box was



Left:  
Lynne Carter  
of Solar Village  
Institute and  
the author of  
this article on  
Jane Sharp's  
PV system.

painted a beautiful blue with a large yellow sun on the front. Jane was sparkling with pride. In fact, when it came time to take photos of the class on the roof of Jane's house around the PV array, Jane climbed right up to be in the picture!

It was Earth Day '95. Since the local newspaper, the Durham *Morning Herald*, had written an article about Jane Sharp and her solar project, the day became a

part of Earth Day events everywhere. Families, friends and others filled with curiosity came by to see the SEI class at work. Jane Sharp was everywhere. She took photos, ordered lunch, and hosted guests. She let 30 people run around her home, drill holes, and climb on her roof.

Jane sat with the news reporters in her living room drinking from a recycled Styrofoam cup. "I think we are going to live a much more satisfactory life in the next 20 to 50 years and I intend to help with it," she said. "I'm probably not going to be around for another 50 years," Jane said and smiled, a bright gleam in her eyes, "but I'll be around for a while."

### Access

Lynne Allen Carter, c/o Solar Village Institute, 5840 Jewell Road, Graham, NC 27253. • Phone/FAX 910-376-9530

Solar Energy International, PO Box 715, Carbondale, CO 81623 • 970-963-8855 • FAX 970-963-8866

Go Solar Enterprises, PO Box 422, Richfield, NC 28137 • 704-463-1405



## SOUTHWEST WINDPOWER

camera ready on negatives  
four color  
7.5 wide  
5 high

PHOTOCOMM

full page, bled  
four color  
on negatives

this is page 13



# Solar-Powered Paradise

“(Beatrix and Andrew’s home) is an integral part of a design scheme ... to fill an old lava field with lush vegetation.”

Don Monkerud

©1995 Don Monkerud

**W**hen Andrew Terker and Beatrix Pfleiderer built their house overlooking a beach on the southeastern tip of “the Big Island” of Hawaii, solar power was more than an afterthought. Besides cutting down on the expense of bringing power to their remote home, Andrew and Beatrix had a larger vision.

For Andrew and Beatrix, solar power is an integral part of a design scheme that includes water, organic agriculture, energy and house design in a sustainable system that is filling an old lava field with lush vegetation.

“We designed our house as an example of how to live on the planet without detracting from it, a way for humans to live in harmony with nature,” said Andrew. “We are integrating solar power with permaculture, a permanent self-sustaining agriculture in which everything feeds on everything else.”

Andrew first came to Hawaii in 1981 to teach at the University of Hawaii in Hilo. Both are psychotherapists and Beatrix is also a writer with a speciality in anthropology in India and traditional therapies. In addition to running their farm and writing, they regularly

conduct seminars in Europe. Soon, the two decided to design a house—one that fit with its surroundings.

One thing a new home builder learns quickly about Hawaii is the variation in climate, rain fall and the amount of soil that’s available for growing plants. The island of Hawaii is essentially a series of five volcanoes. The northern-most volcano, Kohala, is four million years old and the newest, Kilauea, continues to spill lava into the sea, creating over 500 acres of new land in the last year alone.

The eastern side of the island that faces the mainland is wet, and the western side is dry. As one goes up the slopes of the volcanoes, rainfall increases, the temperature drops, and the vegetation increases. It was on this wetter, eastern side that Andrew and Beatrix decided to build.

### Permaculture

Coconut trees line the beaches outside Pahoia on the way to their house, and the low lying land is filled with old basalt lava flows and spotty vegetation in an area of sparse population. Just up from a black sand beach, the house, on tall posts made from native Ohi’a trees, looms above short vegetation and looks out to the ocean as if contemplating distant spaces. A lush garden surrounds the house.

There is no evidence of water. No springs, rivers or wells exist in the area that frequently sees lava flows sweep everything in its path, leaving jagged and clinky a’ala lava and smooth, ropy pahoehoe lava in its wake. Water is collected from rainfall off the roof of the main

house where it flows into a 16,000-gallon, two-thirds underground, one-inch-thick ferro-cement tank.

Overflow goes to a ferro-cement pond that grows water hyacinth, lotus and algae. These plants fix nitrogen and make excellent fertilizer when added to the base of the many trees and ornamental exotic tropical trees planted on the property. Water is pumped, with a 24 Volt DC pump from the pond into a drip irrigation system to water the plants.

“We tried to choose drought-resistant, nitrogen-fixing plants so we could build the soil,” said Andrew. “When we came here, there was no soil, only a lava field. We bulldozed the lava and brought in cinders and some soil to get started.”

Pineapple, banana, papaya and guava plants provide shade, greenery and food. When asked about the many taro plants growing in the garden, Andrew crinkles his nose and explains that poi, a paste-like substance made from pulverized taro, is an acquired taste still considered a delicacy by many native Hawaiians. He prefers steamed taro and points out that it is a staple in Polynesia.

Even the vegetable garden—with its lettuce, spinach, Chinese cabbage, tomatoes and other plants—fits into the overall subsistence plan. The exhaust of the 6 kilowatt Onan propane backup generator is directed into the vegetable garden to provide plant nourishing carbon and water. Despite many natural predators, the garden yields healthy vegetables year around.

“I just grow things that work,” Andrew said. “If it doesn’t grow well, I don’t grow it rather than put in a lot of extra effort.”

While the house isn’t totally self-sustaining, it comes close. Future plans include using methane to produce gas for both electricity and to run vehicles. The newer type wind generators may also be tried, because they can withstand the bursts of 120 m.p.h. winds by tilting out of the way and by resisting the marine climate that destroys metals.

Andrew and Beatrix also own La’akea Gardens, a 23-acre parcel on the slopes of the nearby volcano, which they believe is the only operating tropical permaculture farm, at least on the Big Island, and possibly in the world. The demonstration farm is being converted to an organic vegetable and exotic tropical plant farm and is already self-sustaining by selling organic vegetables to local health food stores and restaurants. They take inspiration from *Permaculture: A Practical Guide for a Sustainable Future* by Bill Mollison and plan to offer classes on permaculture at their farm in the future.



Above: Beatrix Pfleiderer and Andrew Terker

### Making the Vision Work

Like other visions, this one required lots of planning and effort to bring to fruition. When the house was built in October 1992, grid electricity wasn’t available. Power lines are just now coming into the area and are creating a controversy because only 38 lot owners out

Below: Pineapple, banana, papaya and guava, even taro plants and a vegetable garden yield food year around.



of some 1300 responded to electricity offers from Hawaiian Electric Light Company (HELCO). Trees along the roads will be cut down by HELCO to bring power to lots which will increase \$10,000 in value by being on the grid. Like the majority of people in the local area, Andrew and Beatrix are opposing the electrification by HELCO.

Even if they had waited for electricity, paid the \$20,000 fees to bring electricity to the area and overlooked the fact that 95% of local power comes from imported fossil fuel, commercially generated electricity isn't always reliable. Last year and the year before, there were rolling black outs, sometimes every several days. Additionally the shipping company that provides fuel oil for HELCO had problems securing insurance. Insurers were concerned about potential liabilities of an oil spill along Hawaii's pristine coastline. Independence and reliability also played a role in the choice to use solar power.

Another set of problems then arose. The county required hiring an engineer to design the solar system that added another \$500 to the cost of plans. The county knows little about solar power and wants to shift legal responsibility off the county if something goes wrong. That's why most people in the area save the added expense by saying they are going to put in generators before they get final approval for their building plans.

They used the services of Vince McClellan of Independent Energy Systems in Keaau to design and purchase their solar system for under \$17,000.

"Many people have the idea that using solar power means giving up your current lifestyle," Vince said. "That's incorrect. What we do is use appliances that do the same thing with less energy. With solar power one can save a lot of money by simply being more efficient with power usage."

### **Fitting the House to the Location**

Like many architects today, the architect never visited the building site and didn't understand the wind conditions or realize that daytime temperatures average in the 80s most of the year. Unmodified, the original plans would have made the house an oven.

Andrew and Beatrix modified the plans. In addition to situating the house on the lot to take advantage of the sea breezes, the living space was designed for the second floor, away from the heat conducting earth. The county required they enclose the first floor to provide sheer strength. They built a high house peak and created a double-wall roof. Based on the principle that hot air rises, an air passage in the roof allows cooler air

to enter the bottom of the eaves and hot air to rise out the roof peak. This made the roof a foot thick, but the house stays cooler than it normally would in this tropical climate. The county also insisted upon double wall construction, adding further to the cost of building.

One is easily overwhelmed by the house, so much so that the average person could easily forget that the house is solar powered, or that the house is a sustainable system, or that the whole piece of land works together like pieces of a puzzle that fit snugly together. Originally conceived as a place to hold workshops, the 4,000 square foot house is larger than Andrew and Beatrix need for daily living—the living room alone is 1800 square feet. Wood grain predominates in the post and beam construction.

Although this was his first job as a contractor, Clive Cheetam, a local craftsman and woodworker, fitted the house together like a piece of fine furniture. The house contains a plethora of naturally finished woods. Native Ohi'a provided the house beams, Koa provided doors, trim and cabinets, and native Kamani, Guava and monkey pod other accents and beams. Redwood forms the outside walls, cedar the ceiling, oak the stairs and local eucalyptus the flooring. Recycled wood from abandoned house projects allowed them to get the most from their money.

A 21-foot doorway opens onto the deck from the living room and a series of sliding screens and doors roll out of the way to leave an unimpeded view of the ocean. Outside lighting is standard sconces with halogen bulbs. Inside, indirect lighting predominates. A special 110 vac rope light lays atop the beams, the kitchen uses 24 Volt high-energy compact fluorescent and European bare cable conductor lighting is used throughout the house.

Tram lighting, or European bare cable conductor lighting, operates from a negative and a positive DC wire at 24 Volts directly from the battery. In Europe the current is normally transformed from 220 Volt to 12 Volt DC, but Vince adapted the system to 24 Volt. Despite much ribbing from the carpenters about the "clotheslines" he was stringing in the offices and living room, Vince pointed out that the system allows lighting from Halogen bulbs by simply moving the lights anyplace along the line.

While Andrew and Beatrix seldom use more than one lighting system, the system offers a variety of choices for lighting. For example, the bathroom has fluorescent over the sinks, sconces on the walls and ceiling lighting, all on separate switches. Dimmer switches also help conserve power.



### Heat, Wind and Rain

Normally the temperatures in the area seldom dip below 65°F. In January during this interview, daytime highs were 80° and nighttime lows were 70°. Yet the area does occasionally get cool. Trees from La'akea Gardens provide fuel for the small air-tight stove that is used an average 30 days a year. Cool days mean rain and the high humidity leads to mildew. The stove is used for a dehumidifier as much as for heat.

Remember the eastern side of the Big Island is rainy, and this is a rainy area. Hilo, a town of 40,000 people an hour away, received 170 inches of rain last year. It's not unusual for 6-7 inches to fall overnight, and in February, 1979, 30 inches fell in 24 hours.

Clockwise: (Right) The 16-module array tracks the sun with other plants in the garden.

(Middle) Vince McClellan of Independent Energy Systems designed the PV system and installed the components.

(Bottom right) PV power is routed to the Power Center, where it is stored and processed.

(Bottom left) The battery pack is nestled under a counter that holds the inverters.

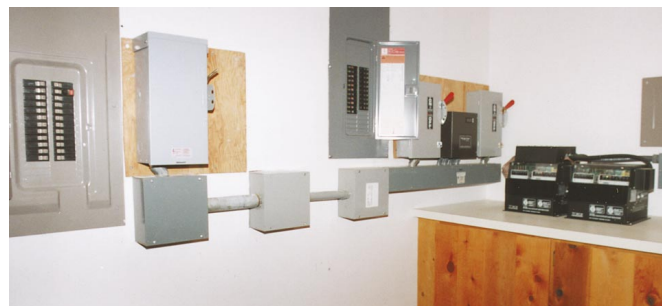

### Andrew and Beatrix's PV System

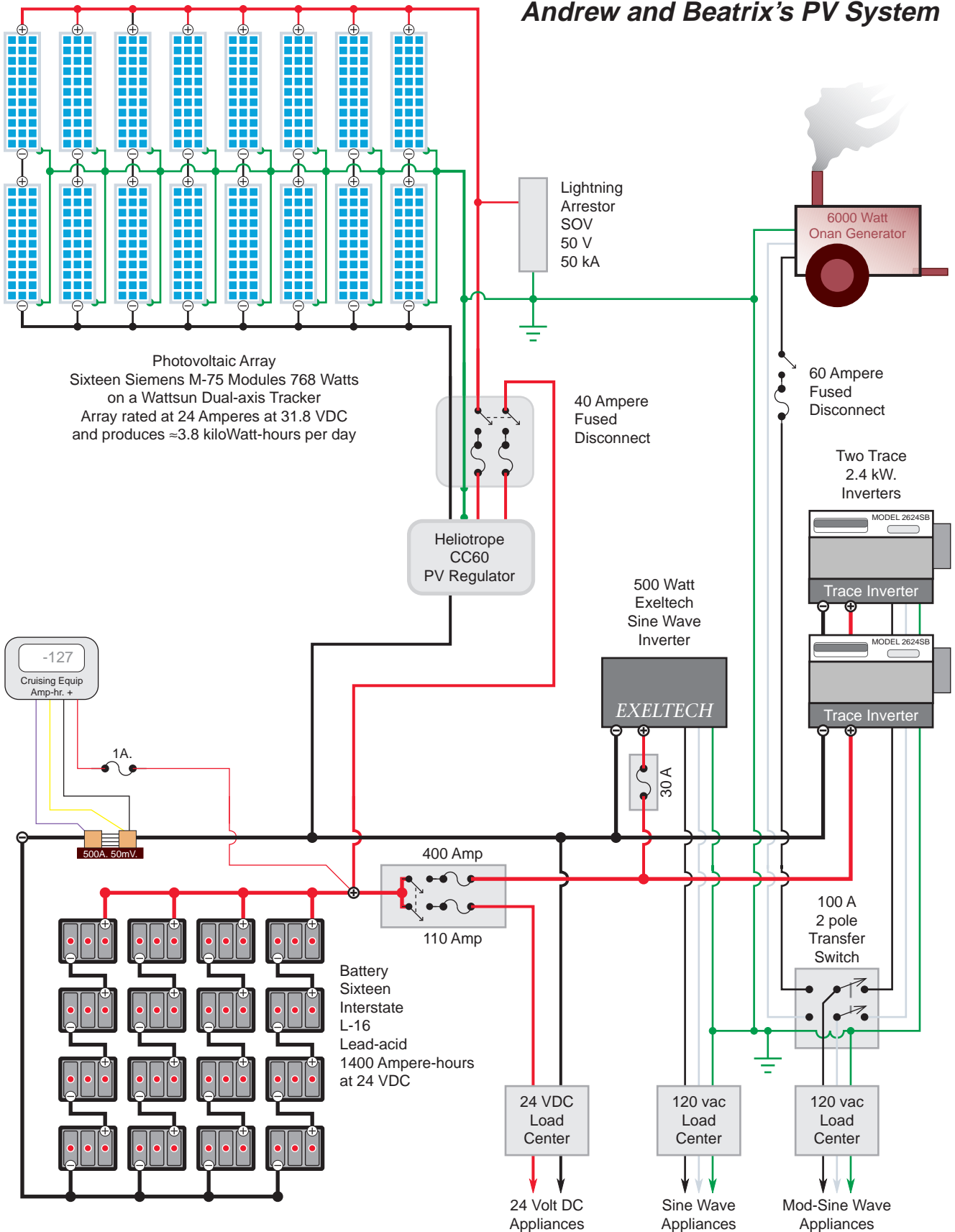

**Andrew and Beatrix's PV System Cost**

#	System Component	Cost	%
16	M-75 Siemens PV Modules	\$5,184	31.7%
2	Trace U 2624 SB Inverters	\$3,190	19.5%
16	Interstate L-16 Batteries	\$2,560	15.7%
1	Wattsun Dual Axis PV Tracker	\$1,720	10.5%
	Installation Costs	\$1,635	10.0%
1	Exeltech SineWave Inverter	\$534	3.3%
	Miscellaneous Electrical Parts	\$500	3.1%
1	Cruising Equip. A-H+ Meter	\$300	1.8%
1	Photron SAM 3-120	\$264	1.6%
1	Fused Disconnect	\$235	1.4%
1	Trace Stacking Interface	\$225	1.4%
<b>Total</b>		<b>\$16,347</b>	

Because the rainfall tends to be concentrated, there's lots of time left for sunshine, and of course, the solar collectors work in cloudy weather. Because this area is close to the equator, the solar modules produce higher amperage than specified for North American locations.

Hot water is provided by solar hot water collectors on the roof that work in conjunction with an automatically controlled French Aqua Star on-demand water heater powered by propane. The desired temperature is set and if, on a cloudy or stormy day, the temperature doesn't come up to the desired setting, the propane automatically heats the water to the desired temperature as it is used.



Left: The sine wave-powered, stereo system routes music to most rooms in the house.

Bottom: The built-in, wrap-around desk ensures a grand backdrop for any office work.

Right: The Sunfrost refrigerator runs directly from the 24 Volt battery bank.



Household water is pumped from the ferro-cement storage tank into an 86-gallon water pressure tank in the utility room Power Center. Two water pumps—a 120 Volt 3/4-horse motor and a 24 Volt booster pump—supply water to the house.

**Power System**

On the ground floor of the main house, the Power Center is the connection and distribution point for all wiring from the photovoltaic panels to the main house, the propane generator and the two guest houses. The house systems are powered by a 768 watt photovoltaic array mounted on a Wattsun dual-axis tracker that keeps the panels pivoted toward the sun within one degree azimuth and elevation. A bank of sixteen 350 Ampere-hour (Interstate L-16's) lead-acid batteries provide a storage capacity of 1400 Ampere-hours at 24 Volts.

A Helirotrope CC-60 E controls the charging current from the solar array. The County of Hawaii requires the charge controller to be isolated from both the solar array and the battery bank. The system uses two 60 Ampere two-pole, fusible safety switches to isolate both negative and positive lines to and from the charge controller.

The stacked Trace U2624 inverters provide 120 Volt power to the main house and the two guest houses. The Exeltech SI 500 sine wave inverter provides 120 vac for sensitive loads such as the stereo, fax and phone. Most of the lighting and some appliances, like the Sunfrost RF-12 refrigerator, run directly off the 24 Volt battery bank. Vince designed the system using direct current straight off the batteries to free capacity in the 5,200 watt main inverter system. Also, using direct current provides the system with power for lights,

## Systems

water pumping and refrigeration when the inverters need to be serviced. Sometimes it can take a while to repair inverters if the inverter needs parts that are not in stock.

The DC system uses a main class T fuse rated at 20,000 A.I.C. and a Square D, 30 circuit QO load center to distribute power to the branch circuits. All of the terminations in the DC wiring that can be are soldered to prevent corrosion in the salt environment of Hawaii. There is no stablock termination in any of the wiring. Stablok terminals are spring-loaded receptacles and switches that allow faster wiring during installation. Stablok terminals are not used in solar-powered homes, because there is less contact area on the terminal and with age, the spring can corrode to cause a poor connection. Efficiency is too critical in a PV home to waste electricity in a spring-locked terminal.

The inverters are covered with a special foam-sealed cage to protect the electrical system. If an ant crawls onto the IC board, it dies from the electrical current. When the other biologically driven ants crawl onto the IC board to take the dead ant's body back to the nest, they too die. As the dead ants build up, formic acid in their bodies react with the IC board to dissolve it, hence the safety screen.

"My philosophy," said Vince, "is that the system wiring should last longer than the house."

### Appliances

The kitchen stove is a Sears Kenmore that runs on propane, as does the oven and clothes dryer. The Kenmore dishwasher is used only when guests come for dinner. The 12-cubic-foot Sunfrost refrigerator runs on 24 Volt DC. A standard Kenmore washing machine

also runs on the system. The Kenmore dryer has only been used twice since they moved in. The sun routinely dries all the clothes.

Because they are both writers, Andrew and Beatrix each have 486 DX computers and laser printers in their offices. Music lovers, they have a JVC RX-709v receiver for their complete stereo system with speakers in almost every room. A Cruising Equipment Co. ampere meter on the wall in living room keeps them informed about the usage of their system and a nearby generator switch allows them to operate the sound-proofed generator from the house.

"I feel better here than anyplace I've ever been," said Beatrix. "When I lived in Germany, I felt like I was always being poisoned from car and bus exhaust and from the heating and air conditioning systems in the apartment buildings. You can feel the difference just walking onto this property."

If anything, Andrew and Beatrix moved to this remote tropical garden to escape the rat race and to live in a safe, organic, friendly environment. Their vision includes sharing it with other people. In the future, they hope to take advantage of the current interest in ecotourism and to offer short-term rentals. This would allow them to teach others on the farm about permaculture—a way for us to become one with our environment.

### Access

Author: Don Monkerud, 2220 Pleasant Valley Road, Aptos, CA 95003

System Designer and Installer: Vince McClellan, Independent Energy Systems, PO Box 1183, Keaau, HI 96749 • 808-966-7598



From Here

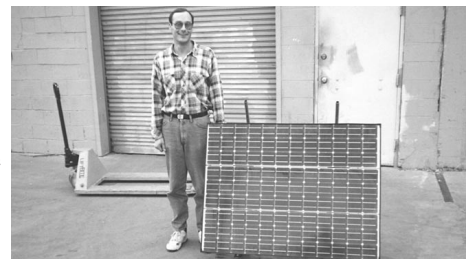

To Here

### SG MODULES

5 year Warranty

for the dealer nearest you call

**800-776-6718**

Unmirrored ARCO M52L

Easy Mounting

OUR HOME PAGE: <http://www.rt66.com/carrizo/>

## CARRIZO SOLAR CORPORATION

*Remanufactured Photovoltaic Modules*

ANANDA POWER  
TECHNOLOGIES

full page  
four color  
on negatives

this is page 21



## A VIEW FROM THE TOP

Richard Perez

©1995 Richard Perez

Life holds few peak experiences—times that are the very best of times. For the last five years running, the Midwest Renewable Energy Fair has been the best in the nation. As I look back on my last five summers, I realize that attending this Fair was the high point of my year. I want to share some of the fun and joy with all *Home Power* readers. So if you missed this year's MREF, then here is part of my photo scrapbook of the Fair. See you there next year!

### A Well Charged Machine

An Energy Fair is a living entity composed of people who work their butts off. The Crew of the MREF is the hardest working in the nation. Not only have they successfully staged five consecutive fairs, but it keeps getting bigger and better every year. This crew has made a successful transition from the core, volunteer, start-up group to a paid full-time crew of two—Christine Hulet and Susan Stein. The mission of the Midwest Renewable Energy

# It's the People!



Above: Smitty from AAA Solar discusses solar energy. In addition to running a solar-thermal booth, AAA also conducted workshops on solar hot water.



Above: Jesse Tatum and Chris LaForge visit at the Great Northern Solar Booth. MREF offers immense opportunities for networking with folks actually living on renewable energy.

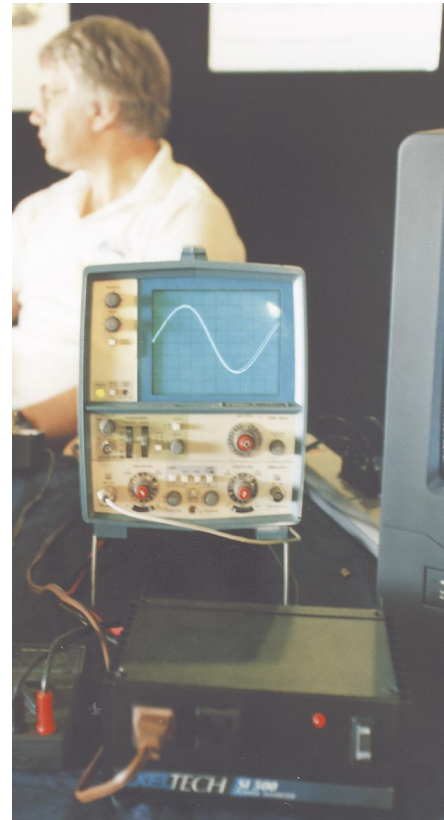

Above: Gary Chemelewski of Exeltech inverters.

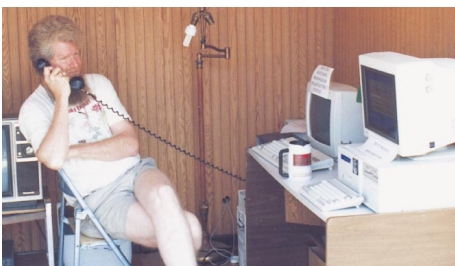

Above: Michael Welch set up a dedicated computer link into the Home Power BBS in Arcata, CA. MREF attendees could log on the BBS and rummage about in the many megabytes of Home Power data.



Above: Bob and Marguerite Ramlow of Snowbelt/Real Goods Energy Center. In addition to living on RE, Bob and Marguerite have been major supporters and workers in every one of the last five years' Midwest Renewable Energy Fairs.



Above: Mickey & Julie Wurl-Koth's Solar Spectrum booth.



Above: John Root of the University of Dubuque had a jam-packed booth featuring an ancient wind-powered Zenith radio. He also put on an incredible kid's workshop that built model solar cars in an hour—and all from recycled parts



Above: Talking to folks is a prime activity at the fair. Here Julie Wurl-Koth (left), Karen Perez (center) and Kathleen Jarschke-Schultze (right) visit and swap RE biz stories.



Above: Tony, Phil, and Andy Jasmin of Lake Superior RE display an extensive array of surplus equipment.



Above: This model home demonstrates wind and photovoltaic electricity, efficient insulation, solar water heating, a low water-consuming bathroom, and the latest in super-efficient home appliances. I had to shoot this early Sunday morning because the booth was too crowded with people when the fair was open to the public.

## *It's the Renewable Energy Hardware!*

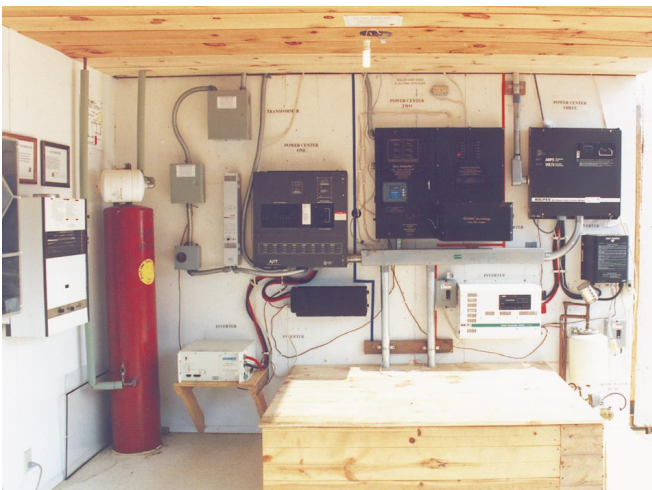

Above: The Power Room of the Model Home. Inside this room there was enough RE hardware to equip three average homes. Inverters were supplied by Trace, Heart, Vanner, and Exeltech. Power Centers were supplied by Ananda, Sun Selector and Heliotrope. Instrumentation was supplied by Sun Selector and Cruising Equipment.. Fair goers could take an hourly tour of the model home and have it all explained by the tour guide. The opportunity to view the latest equipment, and ask questions of those using it, brings folks back to this fair every year.



Above: Mick Sagrillo's Supermarket of Wind. The Lake Michigan Wind and Sun booth had one of just about every wind generator imaginable. From the 150 Watt Marlec to the 10kW Jacobs, all were on display for fair-goers to examine. In addition, the crew from Lake Michigan Wind & Sun was on hand to answer all wind generator questions. There were times during the fair when folks were lined up five deep to access this wonderful wind information.





Above: New products, like this PV-powered piston pump, were on working display.



Above top: Solar cookers, like the Solar Chefs, worked like mad banshees in the over 95° heat.

Above bottom: One of the many electric vehicles at the Fair.

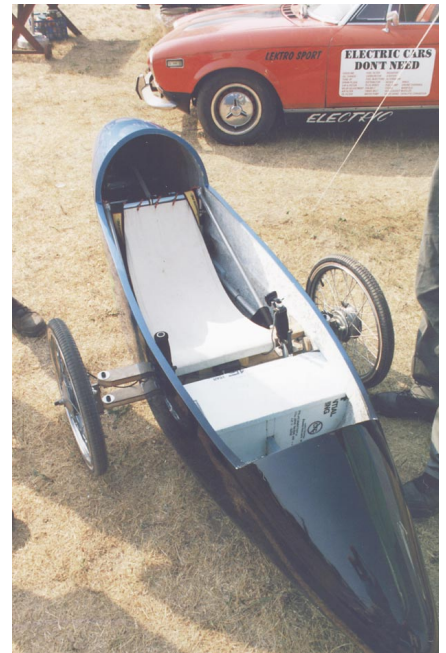

Above: A close-up look at an Electrathon Racer. Electrathon racing is spreading in the Midwest.

Association is clearly stated: to promote renewable energy and energy efficiency through public education and demonstration.

This year's MREF was a model of Midwestern hard work and attention to detail. It ran like a well-charged, electric machine. A crew worked for over a week before the fair to set up all the systems. They installed a 10,000 Watt, utility intertie wind generator on an eighty foot tower. The model home was powered by a variety of PV modules and a 3,000 Watt wind generator.

### Work, Work, Workshops!

MREF has become famous for its workshops. This year over 150 workshops were conducted in the course of the weekend. I personally taught two daily workshops—batteries and inverters. Between twenty and fifty serious students attended each session. These were folks who had done their homework. They had serious questions and had obviously given the subject a good deal of study before ever coming to the fair. It is always a pleasure to work with folks such as these.

There were workshops on every aspect of energy. Workshops were given for every age and experience level. In most cases, these workshops were conducted by people with years of experience in their subject. In some cases, the person conducting the workshop actually invented or revolutionized the technology under discussion.

### Yak, Yak, Yak

Some of the best times I had at the fair were meeting and talking with people. People came from all over the world and the USA to meet other folks who were actually making energy with renewable resources. I met folks from England, Brazil, and Australia, folks from California to Connecticut, folks from everywhere. I must of helped design a dozen or more systems during the fair weekend. We visited with old friends and made many new ones. Silver and Jeremiah Niewiadomski, and I climbed the wind tower to get photos with a

Below: Jim Kerbel's electric Geo Metro. This vehicle has been Jim's primary transport for over two years. It has successfully worked through two Wisconsin winters!





(L to R): Bob and MREA co-executive directors Tehri Parker, Susan Stein, and Christine Hulet.

(Top down): Silver, Richard, and Jeremiah made their annual pilgrimage up the tower.

Photo by Mick Sagrillo

*“People interested in doing energy fairs would do well to match the MREA program.”*

Michael Hackleman

perspective. This yearly climbing of the tower has become a ritual for us. The view from the top is stupendous and energizes me for another year.

MREF is also an opportunity for folks in the RE business to get together. Dealers talked with other dealers about installation problems and successes. Users swapped notes on various products, and took advantage of the bargain prices on equipment at many of the over 90 booths.

And talk folks did. Even at the Sunday morning pancake breakfast, folks were still talking renewables. This is the sure sign of a seriously delirious crew—they talk the same subject day and night! For most of the folks at the fair, renewable energy has become a serious focal point in their lives. This dedicated, aware, and serious group makes MREF the best energy fair I have ever attended.

**The Beat Goes On!**

As you might expect, the Midwest Renewable Energy Association’s activities comprise more than just the Energy Fair. They offer an on going series of weekend workshops on renewable energy subjects. These

workshops are greatly expanded versions of the hour long workshops presented at the fair. Contact MREA for details. See Access at the end of this article for access data.

**The Long and Winding Road**

After the fair, the Home Power Crew stopped in Chicago on the way home to Oregon. We wanted to visit the folks at Midway Labs and see how they make their concentrating PV modules. And Bob-O and I allowed as how we weren’t leaving Chicago without eating some ribs and listening to some live blues music. Many thanks to Bob Hoffmann of Midway Labs for indulging us.

Every year I travel two thousand miles to attend this fair. Every year it gets better and better. It’s great to get a view from the top.

**Access**

Author: Richard Perez, c/o Home Power, PO Box 520, Ashland, OR 97520 • 916-475-3179 • Internet email: richard.perez@homepower.org

Midwest Renewable Energy Association, PO Box 249, Amherst, WI 54406 • 715-824-5166



**Up to 40% More Power  
From Your PVs**

**Precise, Patented, Reliable  
Quality Aluminum  
Construction  
Limited 10 yr. Warranty**

**Write Or Call For  
Free Literature**

**ARRAY TECHNOLOGIES, INC.**  
3402 Stanford NE, Albuquerque, NM 87107  
Tel: (505) 881-7567 FAX: (505) 881-7572

SIEMENS

full page  
four color  
on negatives

this is page 27



Above: Home Power's "Democracy Rack"

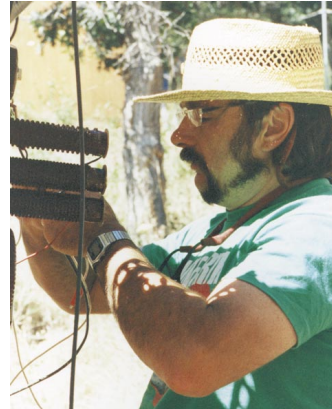

Bob-O Schultze did the wiring & rewiring of the PV modules, and manually rotated the rheostats.

All photos by  
Michael  
Hackleman

Richard Perez operated the analog to digital converter and the Mac Powerbook that logged the PV performance data.



## PV Performance Tests

Richard Perez and Bob-O Schultze

©1995 Richard Perez and Bob-O Schultze

Ever wonder exactly how much power a PV module makes? Ever wonder how much power a PV still makes after years of exposure to the sun? We have. We placed just about every make module widely available on our "Democracy Rack", out in the sun. Then we measured their electrical output, temperature, and solar insolation. Here is what we found.

### Third in a series...

This is the third time we have published current vs. voltage information and curves for PV modules during the last four years. The first "hot weather" test was published in *Home Power* #24, pages 26–30. The second "cold weather" test was published in *Home Power* #33, pages 17–20. Most of the modules we tested have seen over five years of service in the sun and weather. The youngest module (the BP Solar BP585) has only seen one year's service, while the

oldest module (the ARCO 16–1000) has seen over twelve years of sunshine.

### The Test Jig & Procedure

The data for these tests was taken and logged on a Macintosh Powerbook 160 computer. We used a Remote Measurements Systems ADC–1 analog to digital converter to make most of the measurements. We set up the ADC–1 to sample and log the PV's voltage, current, and the sun's solar insolation. The analog to digital converter measured and logged each of these three parameters twice a second. The ADC–1 measured module current using a shunt (10 Amperes, 10 milliVolt, 0.1% accuracy). A Fluke 80T-150U temperature probe and Fluke 87 DMM were used to measure both module temperature and air temperature. A Li-Cor 200SB pyranometer measures insolation. This data was taken at Agate Flat, Oregon (42° 01' 02" N. 122° 23' 19" W.) at an altitude of 3,320 feet.

All modules are mounted in the same plane. This assures equal access to sunlight. Their tilt was 30° which is within 0.5° of perpendicular to the sun when we made these tests (20 August 1995). All modules

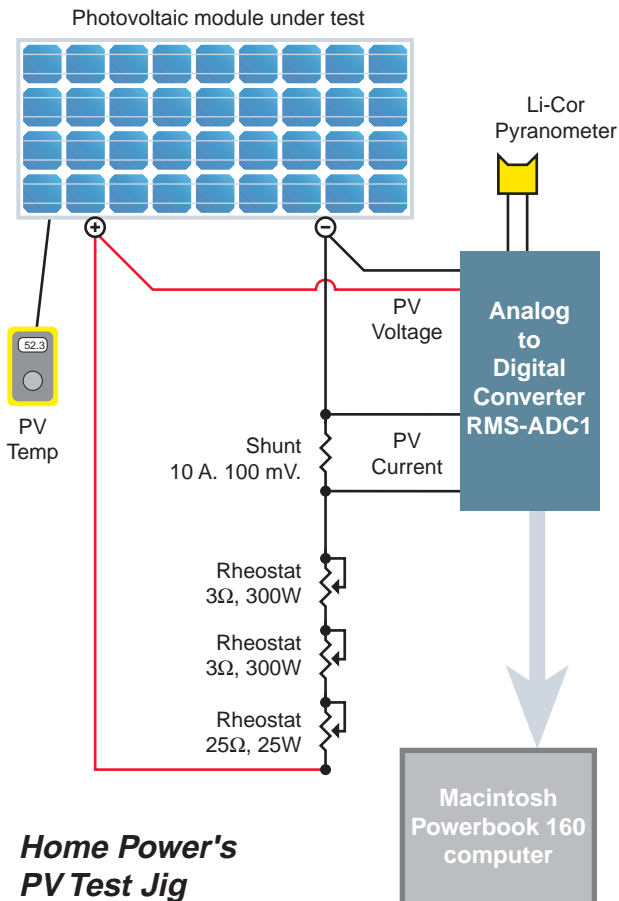

**Home Power's  
PV Test Jig**

were measured with the same instruments in the same places. Ambient air temperature was 31°C. (88°F.) to 35°C (94°F.) with a slight breeze blowing (4 to 7 MPH).

#### **A note on how this data is presented.**

Each module tested has two sets of data presented here. Each PV module has a table giving the manufacturer's specifications and our "in the sun" measured data. Each module also has a graph showing the actual current vs. voltage measurements we made.

Here is an explanation of the short-hand terms used in the tables.

- "Isc" is module short circuit current, in Amperes.
- "Voc" is module open circuit voltage, in Volts DC.
- "Pmax" is maximum module power, in Watts.
- "Vpmax" is the voltage which the module develops at its maximum power point, in Volts DC.
- "Ipmax" is the current the module produces at its maximum power point, in Amperes.
- "PV Temp" is the temperature of the module (back side), in degrees centigrade (°C.).
- "Insolation" is solar insolation, in milliWatts per square centimeter.

All of these terms and units are standards used by the entire photovoltaic industry to rate their products. We used manufacturer's ratings at a 25°C. (77°F) module temperature. In the comparison tables that follow:

- Rated value is the maker's performance specifications.
- Measured value. Our measured data.
- Percent of Rated". A comparison of our measured results with the maker's ratings.

The graphs show module current vs. module voltage. In order to better present this information graphically, we limited the voltage axis of the graph to 12 to 18 Volts. We did, however, log all the data from 0.5 Volts to the module's open circuit voltage. If anyone wishes a complete electronic copy of all of the data we took, you can find it on the *Home Power* BBS at 707-822-8640 or send a floppy disk (please specify Mac or IBM) with SASE return mailer to Richard Perez at Home Power.

Most of these modules have had their performance measured by us during the summer of 1991. We reported on their hot weather performance in *Home Power* #24, page 26. What follows here is another hot weather test on the same group of modules. All are now older and we are looking for degradation in module performance over time. *We found no degradation that we could measure in any of these modules.* In fact, some of them actually tested better than they did four years ago!

*Please note that these are hot weather tests.* PV modules are rated at a 25°C (77°F). temperature. The data we took here was from modules whose temperature was from 49°C (120°F) to 55°C (131°F). Heat causes the PV's maximum power to decrease. This is why almost all of the modules do not make as much power as their maker rated at 25°C. All modules are listed alphabetically by manufacturer's name.

#### **BP Solar BP585**

This is a one year old PV module that we purchased on the open market. It has 36 series connected, single crystal, PV cells. This module was made in Australia using the patented "laser grooving" technique. We've had this module out in the sun for one year.

#### **Carrizo ARCO 16-2000**

This is a 13.5 year old, used, ARCO 16-2000 module we purchased years ago on the open market. It has 33 series connected, single crystal, round PV cells. We've had this module out in the sun for the last 5.5 years. We estimate that this module has spent most of the last 12 years in service. While the potting compound surrounding the cells is extensively browned, the module still delivers good performance. We measured

# Photovoltaics

## BP Solar BP585 - 1 year in the sun

	Rated Value	Measured Value	Percent of Rated	
Isc	5.00	5.43	108.6%	Amperes
Voc	22.03	18.70	84.9%	Volts
Pmax	85.00	68.78	80.9%	Watts
Vpmax	18.00	14.36	79.8%	Volts
Ipmax	4.72	4.79	101.5%	Amperes
PV Temp	25	51	202.0%	°C.
Insolation	100	106	106.0%	mW/sq. cm.

BP Solar BP585

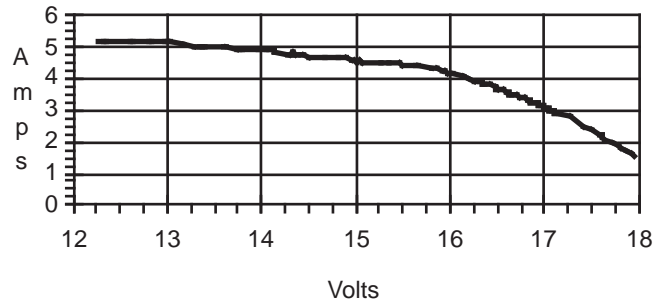

## ARCO 16-2000 - 5.5 to 12 years in the sun

	Rated Value	Measured Value	Percent of Rated	
Isc	2.55	2.30	90.2%	Amperes
Voc	20.50	16.84	82.1%	Volts
Pmax	35.00	27.23	77.8%	Watts
Vpmax	15.50	13.22	85.3%	Volts
Ipmax	2.26	2.06	91.2%	Amperes
PV Temp	25	52	208.0%	°C.
Insolation	100	106	106.0%	mW/sq. cm.

ARCO 16-2000

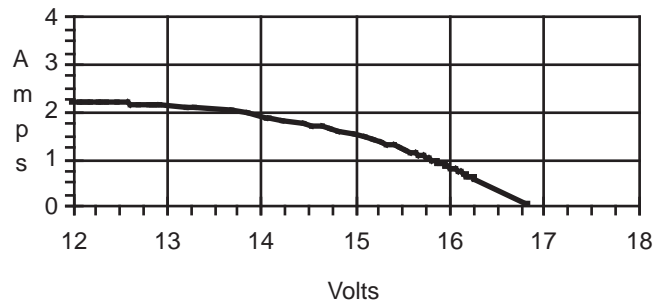

## Carrizo Super Gold Trilam - 1 year in the sun

	Rated Value	Measured Value	Percent of Rated	
Isc	7.00	8.67	123.9%	Amperes
Voc	21.00	20.52	97.7%	Volts
Pmax	105.00	103.70	98.8%	Watts
Vpmax	16.60	14.07	84.8%	Volts
Ipmax	6.30	7.37	117.0%	Amperes
PV Temp	25	50	198.0%	°C.
Insolation	100	106	106.0%	mW/sq. cm.

Carrizo Super Trilam

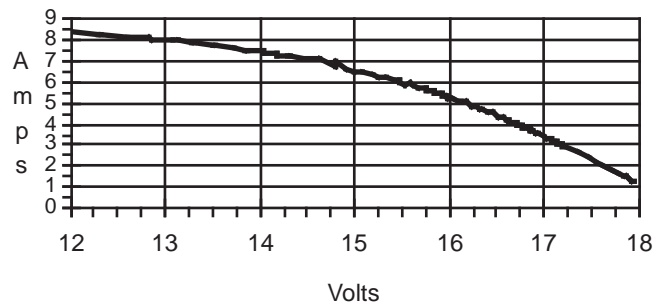

## Kyocera LA361K51 - 5.5 years in the sun

	Rated Value	Measured Value	Percent of Rated	
Isc	3.25	3.42	105.2%	Amperes
Voc	21.20	18.46	87.1%	Volts
Pmax	51.00	43.14	84.6%	Watts
Vpmax	16.90	13.96	82.6%	Volts
Ipmax	3.02	3.09	102.3%	Amperes
PV Temp	25	55	220.0%	°C.
Insolation	100	109	109.0%	mW/sq. cm.

Kyocera LA361K51

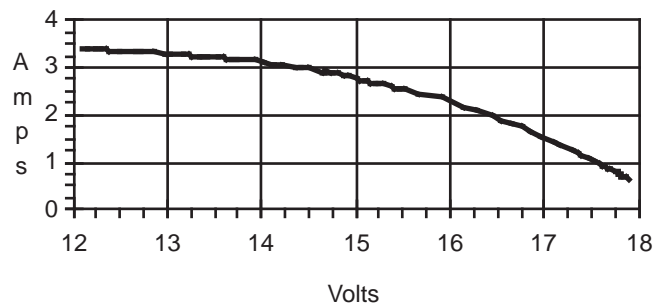

**Siemens M55 - 5.5 years in the sun**

	Rated Value	Measured Value	Percent of Rated	
Isc	3.35	3.67	109.6%	Amperes
Voc	21.70	18.72	86.3%	Volts
Pmax	53.00	48.02	90.6%	Watts
Vpmax	17.40	14.64	84.1%	Volts
Ipmax	3.05	3.28	107.5%	Amperes
PV Temp	25	54	216.0%	°C.
Insolation	100	109	109.0%	mW/sq. cm.

Siemens M55

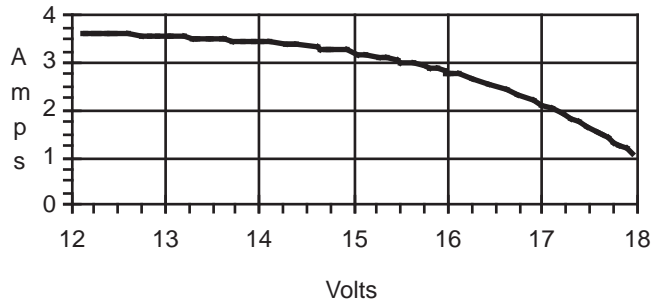

**Siemens PC4JF - 2 years in the sun**

	Rated Value	Measured Value	Percent of Rated	
Isc	4.80	5.01	104.4%	Amperes
Voc	22.00	18.43	83.8%	Volts
Pmax	75.00	59.05	78.7%	Watts
Vpmax	17.00	13.42	78.9%	Volts
Ipmax	4.40	4.40	100.0%	Amperes
PV Temp	25	49	196.0%	°C.
Insolation	100	109	109.0%	mW/sq. cm.

Siemens PC4JF

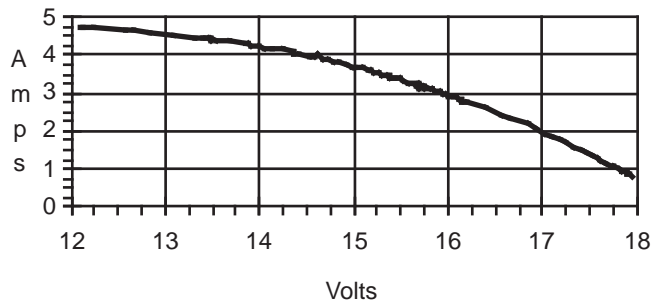

**Solarex MSX60 - 5.5 years in the sun**

	Rated Value	Measured Value	Percent of Rated	
Isc	3.86	3.94	102.1%	Amperes
Voc	21.10	18.02	85.4%	Volts
Pmax	58.90	44.22	75.1%	Watts
Vpmax	17.10	13.69	80.1%	Volts
Ipmax	3.50	3.23	92.3%	Amperes
PV Temp	25	54	216.0%	°C.
Insolation	100	108	108.0%	mW/sq. cm.

Solarex MSX60

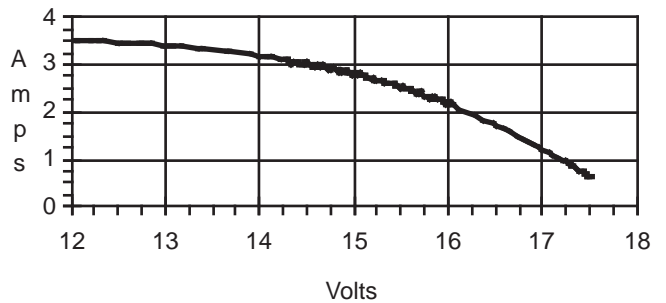

**Solec S50 - 4.5 years in the sun**

	Rated Value	Measured Value	Percent of Rated	
Isc	3.30	3.35	101.5%	Amperes
Voc	20.30	18.16	89.5%	Volts
Pmax	50.00	38.93	77.9%	Watts
Vpmax	17.00	13.66	80.4%	Volts
Ipmax	3.00	2.85	95.0%	Amperes
PV Temp	25	50	200.0%	°C.
Insolation	100	109	109.0%	mW/sq. cm.

Solec S50

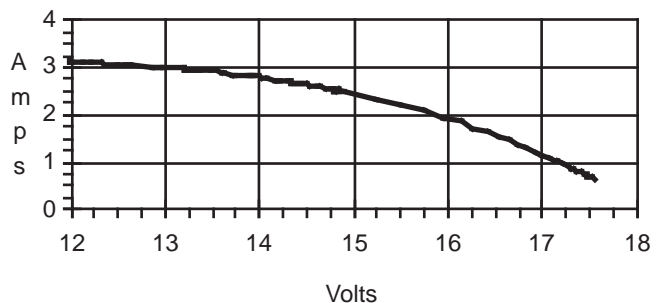

## Photovoltaics

### Sovonics R100 - 7.5 years in the sun

	Rated Value	Measured Value	Percent of Rated	
Isc	2.74	3.00	109.5%	Amperes
Voc	25.00	18.27	73.1%	Volts
Pmax	37.00	29.24	79.0%	Watts
Vpmax	17.20	13.23	76.9%	Volts
Ipmax	2.10	2.21	105.2%	Amperes
PV Temp	25	51	204.0%	°C.
Insolation	100	108	108.0%	mW/sq. cm.

Sovonics R100

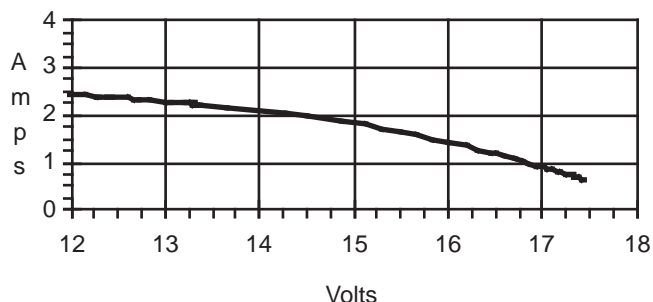

### UniSolar UPM880 - 2.5 years in the sun

	Rated Value	Measured Value	Percent of Rated	
Isc	1.80	2.03	112.8%	Amperes
Voc	22.00	19.60	89.1%	Volts
Pmax	22.00	22.39	101.8%	Watts
Vpmax	15.60	14.26	91.4%	Volts
Ipmax	1.40	1.57	112.1%	Amperes
PV Temp	25	52	208.0%	°C.
Insolation	100	108	108.0%	mW/sq. cm.

UniSolar UPM880

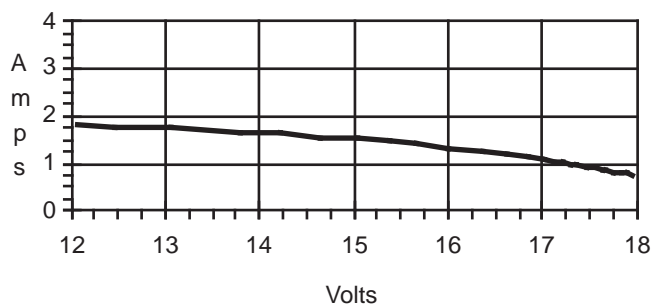

its maximum power at 27.23 watts, up 1.5 watts from the 25.88 watts we measured four years ago. Not bad for a teenaged PV module.

### Carrizo Super Gold Trilam (3 @ ARCO M52L)

This module was sent to us by Carrizo for testing. It consists of three used ARCO M52L laminates connected in series. We've had this module in the sun for one year, but these laminates have obviously seen sunshine before. The hot weather performance of this used module is very good, it made 98.8% of its 25°C power rating even though it was at 50°C.

### Kyocera LA361K51

We tested a K51 Kyocera module that we purchased new on the open market. This module contains 36 series-connected, square, multicrystal PV cells. We've had this module out in the sun for the last 5.5 years. We measured maximum power at 43.14 watts, up over 3 watts from its test four years ago.

### Siemens M55

We tested a M55 Siemens module sent to us new by its maker. This was a current production, single-crystal, PV module. This module contains 36 series-connected square PV cells. We've had this module out in the sun for the last 5.5 years. Hot weather performance is good at 48.02 watts, up about 3 watts from four years ago.

### Siemens PC4JF

We tested a PC4JF Siemens module sent to us new by its maker. This was a current production, single-crystal, PV module. This module contains 36 series connected PV cells. We've had this module out in the sun for the last 2 years.

### Solarex MSX60

We tested a 5.5 year old, MSX60 Solarex module that we purchased new on the open market. This module contains 36 series-connected square PV cells. We've had this module out in the sun for the last 5.5 years. We measured maximum output power at 44.22 watts, up 0.1 watts from four years ago.

### Solec S50

The Solec S50 is a single crystal silicon module using 36 series connected square cells. This module was purchased retail and has been out in the sun for 4.5 years. This is an older model module and was made eight years ago. We measured a maximum power of 38.93 Watts.

### Sovonics R-100

This is an amorphous silicon module. We've had this module out in the sun for the last 7.5 years. We measured a maximum power of 29.24 Watts, up 2.4 Watts from our testing four years ago.



### Uni-Solar UPM 880

This is a model UPM880 amorphous silicon module sent to us by United Solar. This module has seen sunshine for 2.5 years. Since this module arrived after the last hot weather test, we have no previous hot weather data on it. It is, however, an outstanding hot weather performer producing 22.39 Watts, and that's slightly above its 25°C. rating even though this module was at a temperature of 52°C (126°F). We've heard quite a bit of speculation about performance degradation in amorphous silicon modules. This UPM 880 has seen 2.5 years of service and still makes more than its rated power. And it does it at over 200% of its rated temperature.

### Conclusions

The 25°C. temperature rating standard for PV module rating was poorly selected. Out in the sun, these modules are cooking at 50°C (122°F) or more. This causes voltage loss in the cells which in turn lowers the module's power output. If you live in a warm climate, *derate* the maker's 25°C power spec by 15% to 25% to compensate for module heating. A more realistic temperature for rating PV modules would be in the range of 40°C (104°F) to 50°C (122°F) because this is where most modules spend most of their operating lives.

We are very pleased not to have any PV module degradation problems to report. Most of these modules have spent over five years in the sun, yet show no measurable degradation. When PV makers give you a warranty of less than ten percent power loss in ten years or more, they are *really* being conservative. Chances are that all these modules will make 90% of their rated power for twenty years or more.

In addition to the electrical data we have presented here, there is another important bit of information. These modules have survived hail, snow, rain, and thermal cycling for over five years here at Agate Flat. This area is considered a tough environment. No failures. All of the modules still keep on working.

We're not finished yet. We are going to continue testing PV modules out in the sun. We are going to do it on cloudy days, on freezing cold days, as well as the hot ones like today. We invite PV manufacturers to send us modules for extended life cycle testing in a real operating environment.

### Access

Richard Perez, c/o Home Power, PO Box 520, Ashland, OR 97520 • 916-475-3179.

Bob—O Schultze, Electron Connection, PO Box 203, Hornbrook, CA 96044 • 916-475-3401.



## Introducing the new microprocessor controlled

**TRACE**  
ENGINEERING

**C12** 12 Amp 3 Stage Solar Charge Controller  
12 Amp Load / Auto Lighting Controller

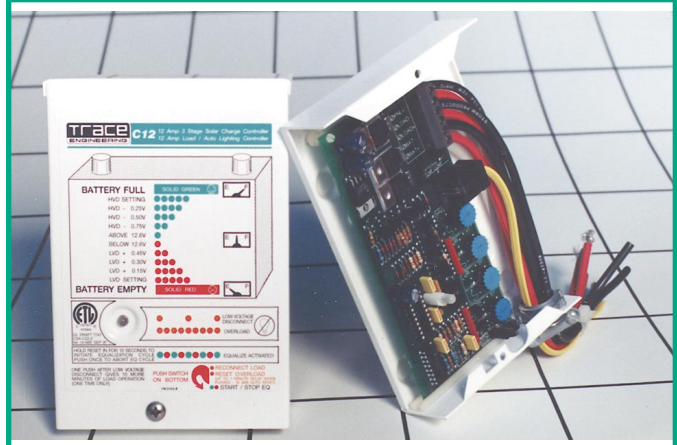

### 12 Amp Solar Charge Controller

Solid-state PWM control with 3 stages (bulk/absorb/float)  
Electronic short-circuit/overload/overtemp protection  
Optional plug-in temperature compensation sensor  
Adjustable bulk and float settings with calibrated scale  
Designed for 15 amps of PV short circuit current  
Automatic or manual battery equalization mode

### and... 12 Amp DC Load Controller

Automatic low voltage disconnect with advanced warning at 5 minutes before LVD  
Electronic short-circuit/overload/overtemp protection with auto reconnection of loads after fault is cleared  
Adjustable LVD/LVR settings with auto or manual reset  
Manual switch gives one 10 minute on period after LVD

### and... Automatic Lighting Controller

Automatically turns lights on at dusk and off at dawn by using the PV array also as a photocell sensor  
Adjustable timer to limit operation from 2 to 10 hours  
Light is turned off if voltage reaches LVD setting  
Manual on switch allows test of lights during day or LVD  
Outdoor rainproof enclosure with conduit knockout

### Applications

- Village Power
- Outdoor Area Lighting
- Telecommunications
- Bus Shelters
- Cabin Systems
- Sign Lighting

**Suggested List Price \$100.00**

**ETL approval to UL1741 in progress**

Contact Your Dealer or Distributor For More Information

**TRACE ENGINEERING**

TEL 360-435-8826 FAX 360-435-2229



## SUPPLIER OF SOLAR AND WIND SYSTEMS

- SOLAR MODULES
  - WIND GENERATORS
  - WATER PUMPING
  - STREET LIGHTING
  - REMOTE PHONES
  - BATTERY BANKS
  - INVERTERS/CONTROLLERS
- USED EQUIP. AVAILABLE

TEL 619-246-7733

FAX 619-246-5770

17451 RACCOON AVE #12

ADELANTO, CA 92301

CAL.#624881

## INTRODUCING — ASE SOLAR MODULES

**LARGEST MODULES IN THE USA—245 to 285 Watts**  
Less Wiring, Mounting, and Installation Time

10 years in business — in Sunny California  
**CALL US FOR PRICING**

# SOLARJACK™

## SCS SERIES BRUSHLESS DC SUBMERSIBLE PUMPS 2 to 50 Gallons Per Minute

SOLARJACK'S SCS series submersibles are high quality, maintenance-free, DC powered pumps designed specifically for water delivery in remote locations.

They operate on 100 to 1000 watts of DC power at 30 to 120 volts. The power may be supplied from solar modules, wind generator, batteries or any combination of the three.

The motors are state of the art, brushless DC, permanent magnet type constructed from marine grade bronze and 304 stainless steel. Designed with a NEMA standard connection, they bolt directly to standard 4" diameter submersible pump ends. Internal pressure equalization allows motor submergence to any depth without damage to seals.

The pump ends are multi-stage centrifugals constructed from marine grade bronze and 304 stainless steel. The impellers and diffusers are constructed from a very rugged thermoplastic extremely resistant to mineral and algae deposits. Field servicing is easily accomplished without the use of specialized tools.

SOLARJACK'S SCS series pumps can be installed below the water level in a well, lake, river, or cistern. They can be used to fill open tanks or used to pressurize water systems. Their small size and light weight allow easy installation into a shallow well by hand.

SOLARJACK'S SCS series pumps are designed for use in *stand alone* water delivery systems. They are pollution-free, corrosion-free, self-lubricating and quiet. There is no better way to provide water for remote homes, campsites, livestock, small farms as well as many other needs beyond the commercial power grid.



### SOLAR PUMPING PRODUCTS

325 E. Main Street, Safford, AZ 85546

(602) 428-1092 Phone • (602) 428-1291 Fax

*We sell them all...*

*Because we've flown them all!*

Write or call for the world's best prices on...

- BWC 850
- BWC 1500
- 10 kW Excel from Bergey Windpower Co.
- Wind Baron 750 from Wind Baron
- Rutland Windcharger from Marlec Engineering
- Jacobs 29-20 from Wind Turbine Industries
- Whisper 600 1000, & 3000 from World Power Technologies
- Windseeker 500 & "AIR" from Southwest Windpower
- Towers for Wind Generators

**SPECIALIZING IN WIND/PV HYBRID SYSTEMS & DESIGN**



**LAKE MICHIGAN WIND & SUN**

3971 E. Bluebird Rd.,  
Forestville, WI 54213  
**414-837-2267**

**FAX 414-837-7523**

*"Wind generators & parts made with wind-generated electricity"*

## Solar Electric Systems

**From a Company Powered by Solar!**



Our shop utilizes its own 2.5 kw array and 35 kw battery bank for daily power needs and testing of new products.



Whether you are looking for one module or a 90-module state of the art, turn key system — Sunelco can be of help.

Sunelco puts the customer first. We offer fast service, factory trained technicians, personal assistance and answers to your questions.

Our large inventory and factory direct distributorships allow us to provide our customers with good pricing and excellent service. We stand behind the products we sell!

### 132 pages of Answers...

Our publication begins with basic load analysis and sizing information and includes case histories, design guidelines and useful in depth data required for system layout. It offers detailed descriptions of solar components and packages, paying little attention to consumer products. A must for every energy library.

### Wholesale Catalog and Service Program

Join our increasing number of dealers who have found a better source for components and support. We offer a high quality dealer program which includes:

- Support unsurpassed in the solar industry.
- Use of the 132 page authorized dealer catalog, one of the best in the industry. Ample space for your company's inserts and labels with no Sunelco return information listed.
- Experienced, professional technical assistance.
- We maintain a large inventory and ship within 24 hours, if not the same day.



P.O. Box 1499HP • Hamilton, MT 59840

order line 1-800-338-6844

technical assistance line 1-406-363-6924



**SOLAR ELECTRIC INC**  
camera ready  
b&w  
4 wide  
2.25 high



Above: A 1kW Soma power the home of Theresa Reid and Peter Rinkin in New Zealand. Mick Lockyer and Greg Hoskins were the contractors on the project.  
Below: The Reid/Rinkin house uses passive solar and wool block insulation.

## Renewable Energy— *Kiwi Style*

Katcha Sanderson

©1995 Katcha Sanderson

**H**aving lived “grid free” since 1983, my husband and I find it interesting to compare notes with other RE (renewable energy) users. It seemed natural to blend our tour of New Zealand with seeing how the Kiwis are using PV, water and wind power.

*Home Power*® helped by printing our open letter announcing our intentions and before we knew it we were rearranging our tour schedule. The sincere and warm responses were nearly overwhelming and we were sad that we couldn’t manage to get around to each and everyone that invited us to stop by. However, we did want to report back on anyone we visited or saw.

### **Theresa Reid and Peter Rinkin’s Wind/PV System**

The first system we saw was at the home of Theresa Reid and Peter Rinkin. Greg Hoskins and Mick Lockyer (electrician and plumber contractors) were our amiable hosts and guides. They had worked closely with the owners to create a very complete renewable energy system for electrical and water needs. Electricity is supplied by a Soma 1 KW wind generator (New Zealand made) and four 64 watt Solarex PV modules. The wind tower is made of three inch galvanized pipe



and stands 13.5 meters tall. The tower is hinged at the base so that the machine can be easily lowered with a refitted boat winch (those clever Kiwis in action!). The wind generator is situated upon a hill with maximum wind access. This hill is about 200 meters away from the house. The battery capacity consists of four Trojan L-16s with a capacity of 350 Ampere-hours at 24 Volts. Refrigeration, clothes washing, lighting, TV & stereo, and water pumping are all supplied via a Trace 2624 inverter. Water is heated by an electrical overflow element from the charge controller or otherwise by a wet-back insert in the wood cook stove. An LPG cooktop supplements the wood stove use.

Rain water is diverted from the house's roof and stored in two 5000 gallon ferro-cement tanks situated on the slope below the house. To create pressure the water is pumped to a smaller tank (1000 gallons) on the hill ten feet above the house, from which it gravity feeds to the house. A water level switch in the upper tank signals the pump to transfer water to the upper tank when the level there falls below about 600 gallons.

The house itself has been designed to make use of solar heat gain thru maximum *north*-facing glazing (southern hemisphere!!). Both solariums use concrete mass in their flooring. Wool block insulation was used throughout the walls and roof. It is a beautiful example of thoughtful planning and a very professional installation. Anyone seeking assistance with a solar system would be well advised to make use of Greg and Mick's talents!

#### **Dave & Raewyn Persson's Wind/PV System**

Our next RE system was the home of Dave & Raewyn Persson. Dave got the PV bug when a teacher introduced him to a solar cell and some small experiments using it. Dave never forgot and when he and Raewyn were having their house built, they incorporated as many alternative ideas as possible.

Water heating is primarily via a two square meter solar hot water panel, but in winter or when it's cloudy out, a "wet-back" inside their wood stove is used. The water is circulated to the storage tank by a small 12 VDC pump (2 Amps). An electric element is located in the tank for times when the stove is not being used. They also have a grey water tank to collect clothes washer water, supplementing their trees in the garden.

Parts for a wind charger found their way to Dave (donations are great!). The Palmerston North area is well supplied with wind. A wiring difficulty in the alternator had it on the bench when we arrived but the single wood-pole tower awaits its replacement. A 67 foot tower obtained for a salvage price is stored for another larger wind generator to be added in the future.



Above: Neale Blaymire's hydro system.

Three of Dave's six Solarex LX137s (37.5 watt) from a dismantled remote receiver site feed the battery bank of 880 Ampere-hours and supplies the Perssons with a very good supplement for their current needs.

During construction, Dave wired in separate 12 VDC circuits for powering lights and stereo equipment in the house and garage. When the system is scaled up, the 230 vac loads will be supplied via a new inverter. Dave is currently using a 300 Watt Electronics Australia model for small power tools and additional lighting on the 230 vac circuits.

A Trace C30A charge controller has replaced the original 16 Ampere BP control to handle the input of the PV array. When the wind charger is back in action and the remaining three PV modules are in place, Dave plans to change the battery system over to 24 VDC to help decrease line losses. 24 VDC is also the preferred input for 230 vac inverters.

Although they are still connected up to the "mains" (grid), their ultimate objective is to cut off the utility power completely and be totally energy independent. That requires the heavy electrical demand of cooking be changed over to gas. It also means the purchase of a more efficient electric refrigerator. We will probably hear the shout of joy here when that does happen!

Likewise in the spirit of alternatives, their Mitsubishi van is one that has been converted to CNG (compressed natural gas) available at most gas (petrol) stations and is a "home grown" product in New Zealand. It was our great honor to be driven to our next location in it! For us Dave and Raewyn's home was a wonderful example of clever use and planning combined with resourcefulness in obtaining equipment. Those who

think RE can't be added to their existing homes could learn a valuable lesson from the Perssons.

### **Christine Martin and Neale Blaymires' PV System**

Christine Martin and Neale Blaymires home in the "bush" (native forest) is our last example of Kiwi alternatives in action. As with almost all RE users, Neale and Christine decided to look into solar after finding out what line extensions would cost to their site. Their current residence is small and their electrical usage scaled to suit. Three PV modules (one BP @ 62W and two ARCO M55s @ 52W) plus a microhydro (30 Ampere-hours per day) supply lighting, "boom box" entertainment, washing machine and occasional sewing machine electrical usage. Halogen incandescent lighting has been used exclusively due to Neale's concern over electromagnetic fields.

The hydro is about 150 feet from the house and consists of a pelton runner driven by 75 psi to turn a Bosch car alternator. The output is 4 Amperes at 17 VDC. Allowing for line losses, 13 VDC arrives at and charges the batteries (Trojan R220/ 220 Ampere-hours at 12 VDC). A rain-fed stream fills the 12,000 liter ferro cement reservoir made by Neale which in turn feeds the hydro. The hydro is remotely switched on by a solenoid so that the power is only used when needed to supplement the PV. The 24 vac solenoid (irrigation equipment) has failed twice and will be replaced by a DC solenoid for which Neale recently found a local supplier. Neale promises a hydro article in the near future for *Home Power*.

Neale's power center has a 230 vac, 300 watt sine wave inverter (Rainbow Sine/ Australia) and a 700 watt stepped wave inverter (Ebbett/New Zealand). Due to high standby draw, Neale modified both inverters to have remote activation from inside the house. I used the 700 watt inverter when Neale let me use their 600 watt, 230 vac traveling iron that Christine uses for sewing projects. Their system also has a planned "phantom load" of 7 watts for some small lights placed inside Christine's piano to keep it dry and in tune! Cooking, refrigeration, and water heating (on demand) are all LPG powered. Neale is especially glad to have a Cruising Equipment Amp-Hr meter riding herd over their system. Since our visit, Neale has obtained an additional set of batteries which will add 100 Ampere-hours at 24 VDC to the system for their new house.

In all, it's an elegant example of small and thoughtful usage supplied by carefully selected equipment. Christine and Neale will soon be starting their permanent residence. What they have learned here will be blended and built upon in that house. We can't wait to see it and hope they will show it to us all!

### **Peasants by Choice**

Peasants by Choice is a group of very alternative-minded people. We met them within their homes where we all enjoyed discussing RE in NZ. Special thanks go out to Pete & Sharon Sewell of Hamilton, editors of the Peasants By Choice newsletter, for helping to put us in touch with more invitations than we could accept. We had a wonderful time with them at Diane and George's Honey Cottage, the birthplace of this marvelous group. Other PBCer's, Dave and Jean Adamson of Ashurst (who supplement their electrical use via wind) and their friends Brian and Shirley (who use wind to totally power their home), all met with us one night at the Adamson's. Here everyone got to pass on our ideas and suggestions to Tony who was interested in going "mains free" in the retirement home he had just purchased.

All of the discussions we remember seemed to have one thing in common—the users were delighted with their independent systems but had had difficulties obtaining knowledge and equipment. As we traveled on we began to realize that each one of these people had bits and pieces of information about RE, but not near enough to suit them. Resources for RE equipment and suppliers within New Zealand were not easily found. As a result competition has not helped to lower the high costs often due to single (appearing!) sources for parts. We thought that one way to overcome this might be by networking and making as much information available as possible. Dave and Raewyn Persson think so too and will soon be starting up the Kiwi Alternative Network for KAN-DO people. We wish them the best of luck and any RE interested Kiwi might do well to contact them and get a copy of the KAN-DO newsletter.

With all of New Zealand's wind, sun, water *and* people, we don't see how RE can't be off and powering more and more Kiwis in the very near future. We hope to be able to return soon and see that for ourselves.

### **Access**

Author: Katcha Sanderson, 20295 Panoche Road, Palcines, CA 95043 • 408-628-3362

Hoshins & Lockyer Ltd., PO Box 153, Carterton, New Zealand • (06) 379-7904

Peasants By Choice/Pete Sewell, C/O Telecom New Zealand Private Bag, 3100 Hamilton, New Zealand • (07) 824-8307

Raewyn & Dave Persson Milner, R.D. 3, Palmerston North, New Zealand • (06) 329-7720



SOLARDYNE

7.125 wide  
4.5 high  
four color on negatives

# Renewable Energy on CD-ROM

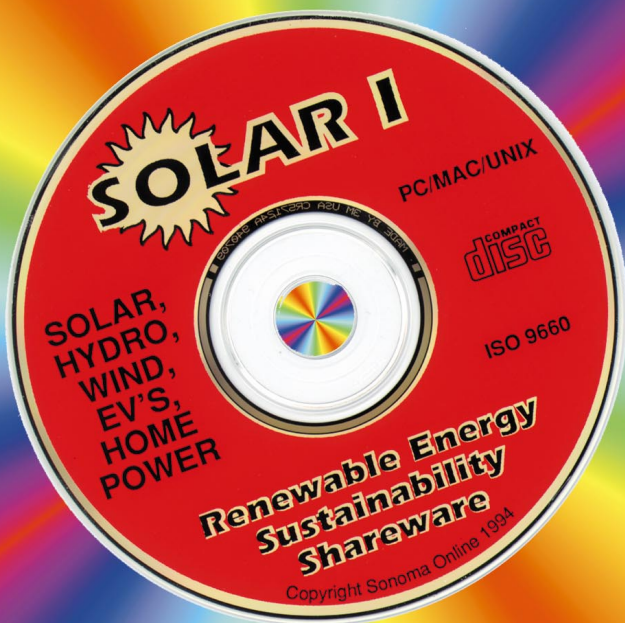

**For Alternative Energy Fans,  
Businesses, Researchers and  
Educators. PC/MAC/UNIX**

Reports, Articles, Newsletters, Programs and  
Graphics on PVs, Wind, Hydro, Controls, EVs,  
Biofuels, Environment and Sustainable Systems

**Article Text and Graphics from  
Home Power Magazine #1-#36**

Includes: 250 Megabytes of Shareware and PD  
Software for Macintosh® and PC Compatibles

**Home Power**

PO Box 520  
Ashland, OR 97520  
916-475-0830

**\$29<sup>00</sup>**  
ppd

International Orders  
Add \$3



**For Credit Card Orders Call Home Power at 800-707-6585**

# Pleasing the Neighbors

William A. Gerosa, Jr. AA2TS

©1995 William A. Gerosa, Jr.

**H**ere in a small suburb not far from New York City, dreams of massive solar arrays with finely tuned heliostat trackers are just that—dreams. To keep myself out of trouble with the neighbors and anyone they decided to haul into the quarrel, I decided to make a small addition to our existing deck to handle solar panels.

## The Hardware

The heart of the system is comprised of four ARCO Quadlam Panels available from Solar Electric. Wired in series, these panels are rated at 17.1 Volts at 5 Amperes in full sunlight. I find this to be a little off the mark as I have recorded many instances of 6 Amperes output on clear days. The panels have been producing 20 to 30 Ampere-hours per day during June. These figures are for days with relatively little cloud cover. A very cloudy day can yield as little as 6 to 8 Ampere-hours. I mounted these panels to the deck railings using brass hinges. A strut supports each panel. Using struts of different lengths allows me to match the sun's elevation. This will be done four times a year.

## Batteries and DC Loads

The panel array feeds into an 8 Ampere charge controller made by Collins and Associates, Inc. I have the controller set for 14.5 Volts. I have found this to be an optimum setting for the batteries I use. The main battery is a Sears deep cycle marine battery (#96522) capable of storing 115 Ampere-hours. This battery is under the same deck that the panels are mounted on. An odd twist to this system is that there is another sealed gel cell in my room that is wired in parallel to the main battery bank. This battery holds 15 Ampere-hours, making the system's total capacity 130 Ampere-hours.

This second battery was needed due to the fact that my room contains an ICOM 707 HF Amateur radio that can draw 15 Amperes on transmit. I also have an Alinco DJ-580T VHF/UHF transceiver with an RF

Concepts RF amplifier. When transmitting, this VHF/UHF radio and RF amplifier combination draws 6 Amperes. I could only run 14 gauge wire from this room, along the outside of the house, to the Sears main battery. So, a second, smaller battery pack in my room avoids a voltage drop of 10-20 Amps through 14 gauge wire. I chose a sealed gel cell to avoid any gases since the pack does sit inside living quarters.

## 120 vac Loads

In addition to the DC loads on the system, all of the lighting in the basement is powered by this solar system using a 300 watt Power To Go inverter made by Clearline Concepts Corporation. The basement contains three 80 watt fluorescent dual tube lamps and one 40 watt single tube lamp. The inverter is a modified sinewave inverter and the square wave it produces does not seem to bring the lights to their full brightness when compared to grid power. Each of the doubles draws 4 Amperes at 13.5 Volts through the inverter. The single tube lamp draws exactly half this amount, 2 Amperes. These figures confirm the notion that the bulbs are not getting a full 80 or 40 watts and therefore are not as bright as possible.

The inverter is wired to the battery using 30 feet of 6 gauge wire. While excessive for this application, the wire will serve a larger inverter in the future. The 120 vac output from the inverter powers a homemade switchbox. Each of the lamps is on its own switch.

The inverter and switchbox lie at the far corner of the basement in relation to the entranceway. I ran a wire from the remote control port of the inverter to a switch panel by the door. This allows the inverter to be turned on when entering the room. I leave at least one of the fluorescent light switches on so that when the inverter is remotely powered up, the entrant has light with which to cross the basement and access the switch panel. Before this addition, I had to walk across the basement in total darkness to switch on the lights.

## Energy Consumption

If I used all of the lights and all of my ham equipment (assuming 50/50 transmit/receive ratio) for one hour a day, the total current drain would be about 30 Ampere-hours. With a 90% inverter efficiency, this 30 Ampere-hour figure is low. I rarely use everything for a good solid hour each night. I use 10–40% of all of the loads about four times a week for just under an hour each evening. So, I expect an energy surplus over time. A second 115 Ampere-hour marine cycle battery may be added to give the system more storage depth.

## Safety

The inverter has a built-in 30 Amp fuse. In addition, the wire from the battery is fused right at the battery. Each





Above: These four PV modules provide power for communications and lighting.

of the DC load centers is fused at the respective battery. The panel feed to the battery is also fused at the battery on the other side of the inverter (i.e., closer to the panels than the main battery). I am scared by the thought of a shorted battery, hundreds of amperes, and a potential explosion.

#### System Cost

The panels were \$400.00 once the frames were added. Add to this the charge controller (\$35), the Sears battery (\$80), the inverter (\$80), and about \$50 on wire and other unseen necessities.

#### The Next Step

I am seriously considering adding another large battery. On average, the system creates a power surplus, so I plan to add some more loads, too. My room is the first target. Right now I have a 100 watt, a 75 watt, and two 60 watt bulbs—all incandescent. I would love to put in 12 Volt fluorescent bulbs as replacements, but I have found the cost to be high. One outfit wanted \$49.95 for a 20 watt fluorescent (equivalent to a 75 watt incandescent). In light of this, I will be purchasing one 27 watt, one 20 watt and two 15 watt fluorescent bulbs designed for 120 volts AC. In my area every hardware store carries them for about \$20.00 each. Of course, this will require an inverter to be placed in my room.

#### Access

William A. Gerosa, Jr., 134 Palmer Avenue, No. Tarrytown, NY 10591-1616

Clearline Concepts Corporation, 85 Fulton Street, Boontown, NJ 07005 • 201-316-2400

Collins and Associates, Inc., 1735 Archer Street, San Diego, CA 92109 • 619-272-8144

Solar Electric, Inc., 4901 Morena Blvd., #305, San Diego, CA 92117 • 800-842-5678



STATPOWER  
7 wide  
4.9 high  
black and white on negative

## DC Compact Fluorescents

- \* Comes in 12, 24, 36, or 48 volts DC
- \* Will operate a 10, 13, or 18 watt quad lamp
- \* Can also operate a 5, 7, 9, or 13 watt twin tube lamp
- \* Draws 1.2 amps at 13 watts output at 12 volts
- \* Comes with two year warranty
- \* Unit rated for 100,000 hours (one hundred thousand)
- \* 85% efficient at 12 volts 13 watts with 100% output

A product of  
S & H Alternative Energy Products

### Available From:

Alternative Energy Engineering  
Redway, California  
1-800-777-6609

Fowler Solar Electric  
Worthington, Massachusetts  
1-800-914-4131

Sunelco  
Hamilton, Montana  
1-800-338-6844

Kansas Wind Power  
Holton, Kansas  
1-913-364-4407

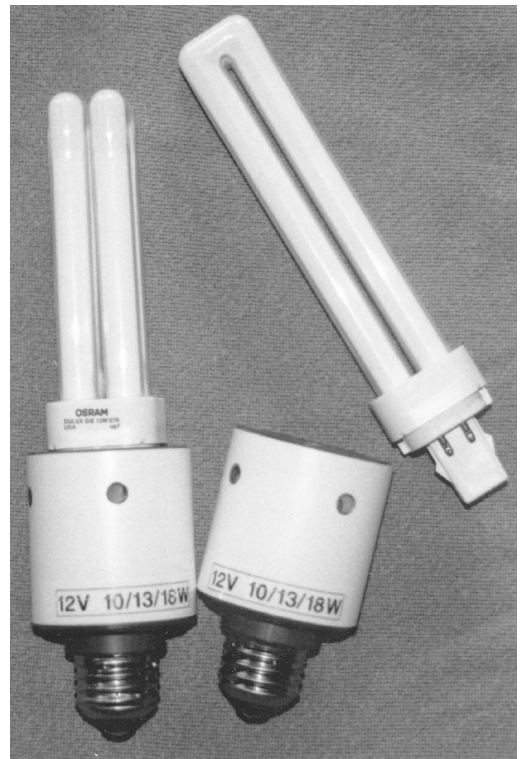



Above: The south-facing Haasch house is solar-hydronic heated.

## ***Gimme Shelter: Solar Hydronic Space Heating***

Mark Klein, James McKnight, Ray Reser, and Dave Shantz

©1995 Mark Klein, James McKnight, Ray Reser, and Dave Shantz

One consideration in the design of a solar-hydronic space heating system is the “summer mode” of the system during hot, humid summers. Sized to temper homes during the heating season (typically 8500 degree days in Wisconsin), these systems provide domestic hot water year round. By mid-June, however, the basement slab and sub-slab storage temperatures reach 70–72°F., above which they begin to affect the comfort factor. The hydronic liquid and the heat-distribution system deserve protection from extremely high temperatures (over 175°F), which will accelerate the aging of the system. We explored these (and other) options before settling on the design we installed.

Our dilemma was a basic reluctance to provide any more significant amounts of heat to the house envelope until beginning the storage cycle again in late August. Although simply draining and idling the system during the summer could be a solution, the time and energy would not be insignificant—our summers are too short already!. Also, domestic hot water would not be available. In addition, there is some value in maintaining the temperature of the mass in the house to prevent condensation in our humid conditions.

In the spring of 1994, while planning the Davenport home (*Home Power* #46), we discussed various strategies for dealing with the summer mode for space heating systems and thought that a simple solution would be to provide some form of partial shading of the panel array. We envisioned a cedar lath or greenhouse screening cover that could be adjusted as needed. This approach was quite workable, but the fact that it still required an additional amount of time and maintenance on the ridge-mounted array led us to consider operating a separate ‘shunt load’ to dump excess heat outside the house envelope.

When we began work on Jane Haasch’s home in the fall of 1994, we used this approach with slab-on-grade construction techniques to develop shunt loads that could also provide some tempering value to the house

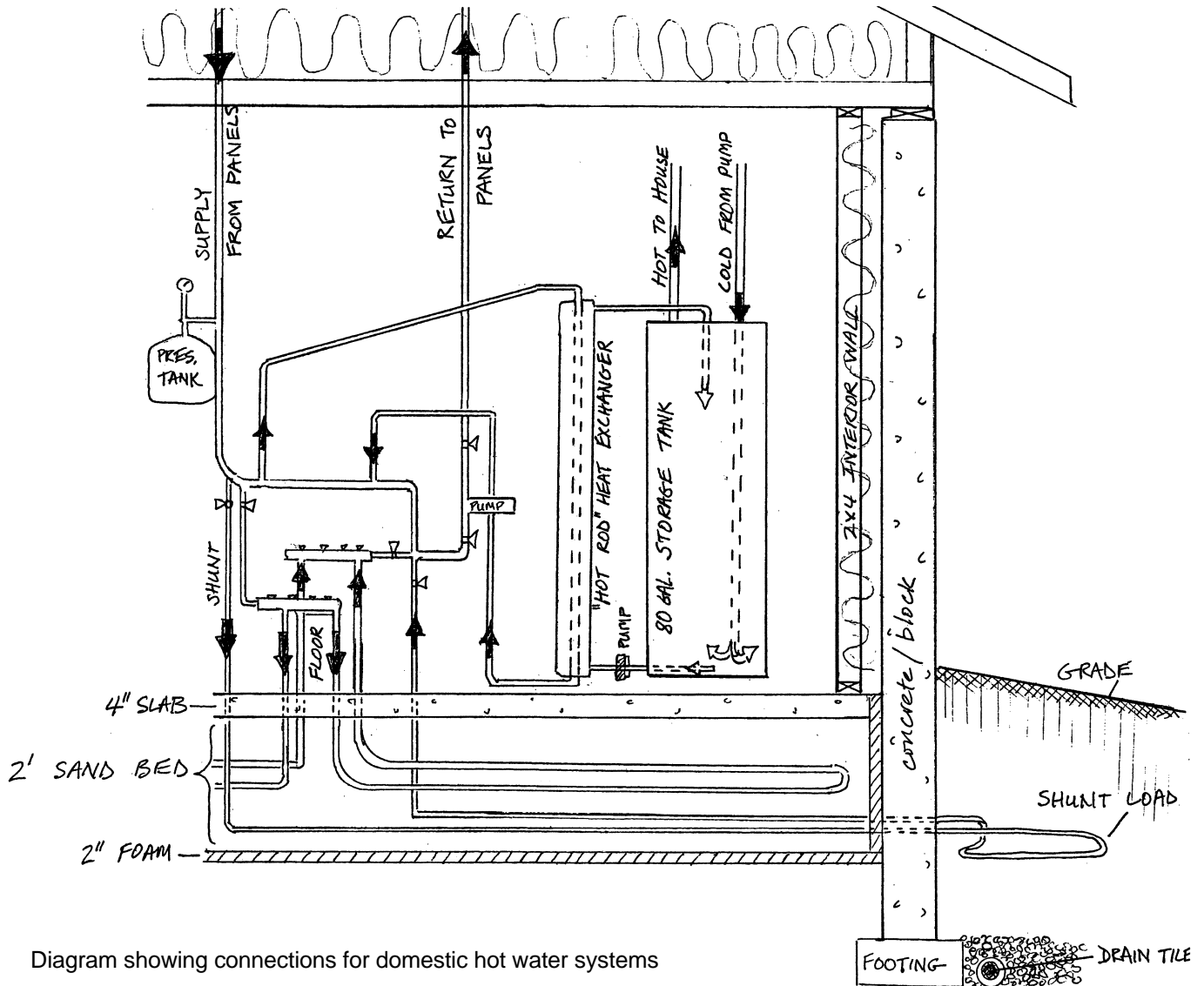

Diagram showing connections for domestic hot water systems

during the heating season. In Wisconsin, frost conditions dictate wall footings 4 feet below grade (explaining the popularity of full basements in the north country.) It's typical to excavate a hole large enough to place footings and walls, allowing 4 feet more around the perimeter for exterior drain tiles and for masons to work. After installing the drain tiles, gravel and filter cloth at footing level, we looped 300 feet of 5/8 inch polyethylene tubing around the house perimeter, linking it through a sleeve in the poured concrete wall to the heating system manifold. (We pressurized the poly loop before backfilling to detect any tube damage. Extra couplings are handy for quick repairs while expensive heavy equipment sits idle!

While constructing the thermal battery inside the house envelope, we placed an additional 300 foot poly loop under the north side of the house floor, through the garage, and out under the driveway. This loop serves

several purposes. It introduces some heat into the north side of the house floor, reducing any potential condensation problems in that area during the humid summer season. It also provides the option of adding heat to the garage and helping snowmelt in front of the garage. As part of the shunt load system, it also reduces resistance for the circulating pump by doubling the area of the tube used in the summer mode.

We've had an unusually hot and humid summer to observe this system and we're satisfied that this shunt approach offers an appropriate level of protection. Temperatures of the system in summertime shunt mode were 130–150°F incoming from the panels, domestic hot water at 110–120°F, and a 90–94°F return from the shunt loop.

In situations where placing one or two loops at footing level are not cost effective, snowmelt loops, hot tubs,

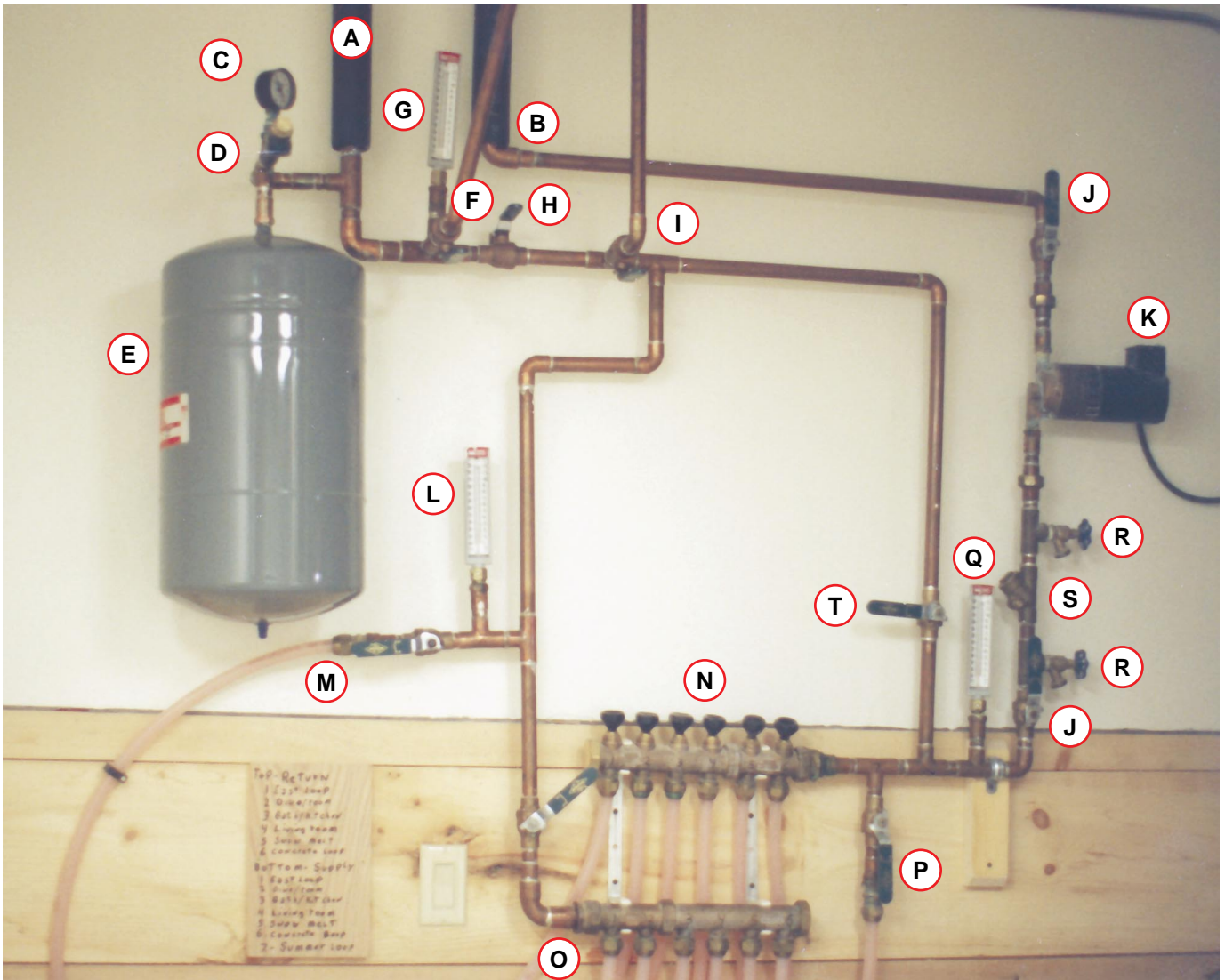

Above : Manifold and controls for solar hydronic space heating system and shunt load system.

- |   |  |   |
|---|--|---|
| <b>A</b> Incoming hot glycol fluid from panels                | <b>I</b> Domestic hot water return w/ball valve                  | <b>P</b> Shunt load return with ball valve  |
| <b>B</b> Outgoing cold to panels                              | <b>J</b> Ball valves to isolate pump (Two)                       | <b>Q</b> Return side thermometer (difference in temperature from supply side thermometer indicates how much heat is extracted by the storage/floor loops) |
| <b>C</b> Pressure gauge (30–40 lbs operating pressure)        | <b>K</b> 18 Watt Hartell pump wired to 18 Watt PV roof panel     | <b>R</b> Boiler drains to fill and charge system with glycol solution   |
| <b>D</b> Pressure relief valve                                | <b>L</b> Thermometer—return side domestic hot water              | <b>S</b> Y-pattern check valve to prevent back flow   |
| <b>E</b> Pressure tank  | <b>M</b> Supply to shunt load w/ball valve                       | <b>T</b> Ball valves to bypass infloor space heating  |
| <b>F</b> To domestic hot water supply w/ball valve.           | <b>N</b> Return side manifold floor/storage bed loops zone valve |   |
| <b>G</b> Thermometer measuring supply temperature from panels | <b>O</b> Supply side manifold floor/storage bed loops zone valve |   |
| <b>H</b> Ball valve control to domestic hot water             |  |   |



Above: The 4 x 8 panels are prepped on the ground, lifted to the solar ridge, bolted through the roof, and plumbed in place. A cat walk provides a good working platform and access for any maintenance.



Above: Envirotech masonry heater module. Stone for the facing was gathered onsite.

**Jane Haasch Residence: 2800 square feet**

**Space heating:** Eight 4 foot x 8 foot Solar King hydronic panels, roof mounted at 60° to horizon. Catwalk access for maintenance inspection. One inch copper supply to manifold in utility room. 60/40 glycol and water solution circulated by single DC Hartell pump powered by 36 Watt photovoltaic panel. 2100 feet, 5/8 inch I.D. Wirsbo polyethelene tubing laid in 2 foot sand bed, additional 600 feet in shunt load. Envirotech masonry heater and bake oven.

**Domestic Hot Water:** 80 gallon storage tank with two hot rod heat exchanger tubes to space heating system; hot water coil off Envirotech masonry heater; Aquastar 125 instantaneous water heater back-up.

**Exterior:** Galvanized standing seam metal roof over wood sheathing, stucco exterior over poured concrete walls. Mavin Low-E windows, preponderance on south side, bermed north side. Orientation magnetic south. Attached sheep barn and covered verandah.

**Insulation:** R-35 blown in fiberglass (B-I-B-S) in walls, R-60 cellulose in ceilings, 2 inch foam below grade to footing depth.

**Mass:** Sand bed under 4 inch concrete slab, plaster over 5/8 inch drywall interior finish, masonry heater and cobblestone facing.

Air-to-air heat recovery ventilation unit by Bryant.

swimming pools or fin tubes under the eaves can also provide a protective load for summertime tempering of the system. In systems where the ratio of domestic hot water use is high in relation to the size of the hydronic array, a shunt load may not be necessary. Where excavation work in new construction is underway, placing these tempering loops deep in the earth surrounding the heated space is a good, inexpensive strategy. With so much effort aimed at providing this heat resource, it makes sense to dump it where it will help temper the living space during the heating season.

#### Access

Authors/Designer/Builders: Mark Klein, James McKnight, Ray Reser, Dave Shantz, Gimme Shelter Construction, PO Box 176, Amherst, WI 54406. • 715-677-4289 • 715-366-2956.

Solar Domestic Hot Water Systems: Real Goods/Snowbelt Solar, 286 Wilson St., Amherst, WI 54406 • 715-824-3982.

Hydronics: Wirsbo (polyethelene tubing) 5924 148th St., Apple Valley, MN 55124; RadiantTech, PO Box 1111, Lyndonville, VT 05851 • 800-451-7593;

AAA Solar Service & Supply Inc., 2021 Zearing NW, Albuquerque, NM 87104, • 800-245-0311



## Let the sun move your tracker!

TRACK RACK™, our passive solar tracker, uses fluid-filled tubes that follow the warmth of the sun and move your photovoltaic modules for you!

- Gain 20 to 55 percent more power
- Savings equal to 3 extra modules a year
- No batteries or gears to replace
- No electronics or motors to fuss over

LIFETIME WARRANTY

Prompt Delivery • Fixed Racks Also Available  
Call for your nearest dealer

1-800-279-6342

Double your outdoor battery life with our **COOL CELL™**  
Passive Temperature Regulating Enclosure

**ZOMEWORKS CORPORATION**

1011 Sawmill Rd NW, Albuquerque, New Mexico 87104 USA

# Alternative Energy Engineering

## Order Toll Free 1-800-777-6609

### New! SolarTek 24 Volt Submersible Pump

Pump water up to 230 feet. A pump controller with over-voltage protection and remote control is included with each pump to insure long life and maximum efficiency. Introductory Price \$695



#### Do You Have A Copy Of Our Catalog & Design Guide?

Send \$3.00 to get 120 pages full of design and product information on solar, wind and water power, inverters, batteries, lights, fans, motors, controls, appliances, water heaters, composting toilets, books and much more.

### High Efficiency Solar Modules

BP Solar's new laser grooved buried grid (LGBG) solar cells deliver up to 18% efficiency. The new BP 585 85 watt module delivers more power per square inch than any module on the market. LGBG cells have higher output current because they have less cell shading from metal contacts, better wavelength response and an improved anti-reflection surface layer. We stock the new high efficiency BP 85 watt module as well as the standard efficiency BP 75 watt module. Both modules have the same frame dimensions and a ten year warranty.

Specifications:	BP585	BP275
Catalog#	11-326	11-325
Peak power	85 watts	75 watts
Voltage @ max power	18.0 volts	17.0 volts
Current @ max power	4.72 amps	4.45 amps
Dimensions	46.8" x 20.9" x 1.5"	
Sale Price	\$540.00	\$450.00

**Dealer Inquiries Invited**

**Alternative Energy Engineering**

P.O. Box 339-HP, Redway, CA 95560

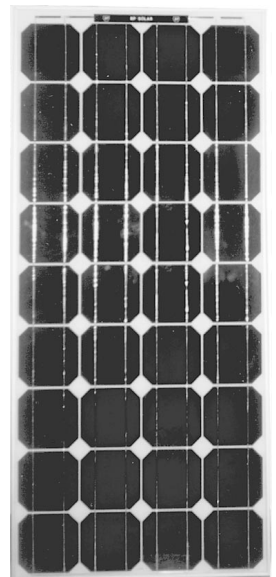

# Get your Infinity — 6 digital power center NOW!

## FACTORY FINANCING NO MONEY DOWN

**0% INTEREST \$99.95 month/12 months**

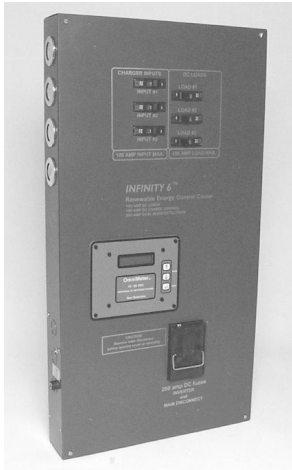

What a DEAL! Now you can get the real thing, an Infinity — 6 DIGITAL POWER CENTER. Save your hard earned cash! Spend it on more PV or whatever else you need! Sun Selector knows how hard it is to pay CASH for everything in your PV system. We're gonna help.

You'll get the new UL listed Infinity — 6 DIGITAL POWER CENTER with all of this:

- ✓ 100 amp PV charge control!
- ✓ 6 plug in breakers, which accept up to #2AWG wire!
- ✓ A complete OmniMeter control system, built-in and pre-wired!
- ✓ Dual 200 amp safety disconnect built-in and pre-wired!
- ✓ RS-232 digital interface (in case you want to plug in your PC for some real fun!)
- ✓ The NEW super heavy duty 16 gauge, all welded steel enclosure with 3 different sizes of knockouts, including a 2" conduit entrance for the inverter!
- ✓ Universal 12-24-36-48 VDC operation!

All this and MORE. It's what you asked for, now it's here! BUT, (There's always a catch) we can't guarantee this offer beyond DECEMBER 1st. Our supply of financing capital is limited so it's FIRST COME, FIRST SERVE. If you want the best, AND you want to KEEP YOUR CASH, act now. Call today for an application.

DEALERS: We are looking for qualified installers to service our retail customers. Contact us now for immediate registration as a contract installer and to get more information on registering as a Sun Selector Digital Products Reseller.

**Sun Selector...Putting the power in YOUR hands!**  
**Post Office Box 1545, Parkersburg, WV 26101 USA**  
**(304) 485-7150 (304) 422-3931 FAX**

## *Solar/PV Deep-Cycle Batteries for the staying power you need*



*How Trojan's solar deep-cycle technology works for you:*

*Exclusive Flexsil®, Multi-rib separators with double thick glass mats extend battery life.*

*Heavy duty, deep-cycle grids with high density oxide mix reduce wear and lengthen product life.*



**Trojan**

**The Better Battery**

**Trojan Battery Company**

**12380 Clark Street, Santa Fe Springs, CA 90670**

**Telephone: (310) 946-8381 • (714) 521-8215**

**Toll Free: 1-800-423-6569**

**Fax: (310) 941-6038**



*GoPower*



# Future, Present, and Past

Michael Hackleman

©1995 Michael A. Hackleman

It's hard for me to describe something until I've seen it myself. This explains why I don't write the editorial until the rest of the GoPower section is laid out. I've just started writing the introduction to *The New Electric Vehicles*, too, signaling that a draft layout is done.

The book has the same format as a Home Power issue—same paper and ink, heavier cover—and 272 pages! The plan is for six signatures (16-pages ea) or ninety-six pages of color (about 250 photos). Good. People are going to be able to see in print what I see on the screen—real-life color about a topic that everyone is talking about.

There's another 250 B&W photos, drawings, tables, etc. I've shunted the "technical" out of the running text (to keep it readable) into hundreds of sidebars. As I look over the book, it feels like it's all there—two decades of EV work. Karen and Richard Perez have assembled some nice machinery to render the book true, have opened their home to me, and let me design it my way. The spreadsheet says we can keep the price low—about \$25. Mid-November release? Soon. We'll know more next issue.

In this issue, I wrote *Sojourns with Hawk* to share some experience is driving an electric motorcycle up here in the mountains. Shari Prange suggests that more important than *what* you have is *how* you use it, in *Driving an Electric Car*.

## Back-pedaling, anyone?

In Steve McCrea's *A visit to the Battery Manufacturing Plant* (also this issue), Richard Komp's *Lead Herring* is a sidebar. I feel the release of *preliminary* results of a Carnegie-Mellon U. study by both a major magazine and newspaper is a discredit to all three institutions. (Briefly, the CMU study concludes that proliferation of EVs will result in large increases of lead lost to the environment.) Intended for peer review, the study is up for a much-needed revision. It would do well to make the corrections suggested in the many letters it received directly (or forwarded from nervous editors). I saw the same errors critiqued, the same corrections suggested. It'd make an impressive set of references.

Since the post-release squabble is usually lost on the public, I expect the "retracts" to go largely unnoticed. Still, it points out how fragile truth is. Data from the hands of someone who wants you to say something about the competition's technology is always suspect. Premature release of study results is also hazardous. It sets off little alarms in people's heads. Is this bias? Is someone pushing? I'm still puzzled how *Science* magazine and *The New York Times* let this slip through. I'd expect them to have hot technical editors. How could they, or the authors, have missed calling up the California Air Resources Board? It's the entity that's *mandating* electric vehicles. This is a *major*, funded study, folks. Couldn't tell just by looking at it. These periodicals *are* classified as non-fiction.



Anyway, thanks to all the folks who helped put out the first fire of the season, through mail, phone, fax, or word of mouth. The public brain is alive and conscious!

## How many EVs?

How many EV (electric vehicles) are on the streets and highways of the USA? Depending on whom I have asked, I've heard figures ranging 500-10,000. Well, if you *exclude* golf carts, ORVs (off-the-road vehicles), prototypes, and other unlicensed electrics, there are really 2,078-2,369 qualified EVs. So says an extensive survey by EVAA (Electric Vehicle Association of the Americas). The breakdown includes OEM (original equipment manufactured, 190), conversions (906), hobbyist (529-695), buses (63), and pre-1990 EVs (390-515). EVAA's survey also puts the bulk of the EVs in six major states: California (587), Arizona (158), Michigan (151), New York (64), Massachusetts (57), and Washington (56). Note that conversions and hobbyist groups lead the charge.

**The big solar race**

Well, the 3rd transcontinental race of solar cars across the USA has been completed. Good sport, that solar racing. Expensive, too! The Cal Poly Pomona Solar Energy Team (CaPSET) sent me a shot of their vehicle, Intrepid Too. Exactly one month before the race was to begin, Intrepid *crashed* during testing at race speeds. Driver Charles Suh needed surgery for facial lacerations. Somehow, the team managed to repair extensive damage to the vehicle and solar array (500 cells were replaced!) and faired well in the racing.

I've enjoyed watching Cal Poly Pomona through races over the years. I recall feeling they were always on a bootstrap. Tenacity 101 is taught at that school. And—their car looks and works like a student-built car. In the spirit of the race, that's because they did it *without* the experienced adults that assist substantially in building other cars. For SunRayce 90, they didn't get nearly the support we (Solar Eagle team) were getting at CSULA.

**Access**

Michael Hackleman, POB 63, Ben Lomond, CA 95005.

EVAA report MB 1995-1 is from EVAA, 601 California St., #502, San Francisco, CA 94108. (415)249-2690.



**POWER OF THE SUN**

SOUTHWEST

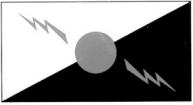

PHOTOVOLTAIC (PV)  
SYSTEMS, INC.



**SOLAREX**  
Authorized  
Distributor

**AUTHORIZED DISTRIBUTOR FOR**  
**SOLAREX AND BP MODULES**

SPECIAL SAVINGS FOR  
QUALIFIED DEALERS!!



..... ————— .....

**WE STOCK QUALITY B.O.S. COMPONENTS BY**  
**TRACE, SCI, SOLARJACK, SHURFLO,**  
**MORNINGSTAR, THIN-LITE, STATPOWER,**  
**SOUTHWEST WINDPOWER**

..... ————— .....

**WE SUPPLY COMPLETE TURN-KEY SYSTEMS**  
**FOR ANY OFF-GRID APPLICATION**

**\$3.00 FOR PRODUCTS & SYSTEMS CATALOG**  
**CALL FOR MONTHLY WAREHOUSE SALE ON**  
**SELECTED PV OVERSTOCK EQUIPMENT**

**212 E. MAIN ST. TOMBALL, TX 77375**  
**PH: 713-351-0031 FAX: 713-351-8356**

**INTELIGEN ENERGY SYSTEMS**

b/w  
on film  
7.1 wide  
4.4 high

# SAFA TEMPO: Electric Autorickshaws

Jose Baer

©1995 Jose Baer

The fax from Henning Bitsch in Kathmandu read, “Dear Jose, This is a different place. I am looking forward to seeing you. Could you bring a DC/DC unit, from 12V to +/-12 V or 24 V @ 50 mA, galvanically-isolated, regulation unnecessary.” It was my first glimpse from afar of what we had gotten ourselves into with the Safa Tempo (clean autorickshaw) project.



A Banjan tree towers above the Safa Tempo as curious bystanders look on.

The Tempo is the local transportation in Kathmandu. It is based on a 40-year old Piaggio design licensed from Vespa for manufacture in India. The diesel version (the most common in Kathmandu) uses a single-cylinder, 10 Hp engine. It belches black smoke at every start and up each hill. The single cylinder causes the whole vehicle to hop up and down while at a standstill, making a terrible racket.

Henning Bitsch and I first met Peter Moulton and Marilyn Cohen of the Global Resources Institute, while we were both still working at SMUD. We were excited to hear about their project for Nepal. The descriptions of traffic conditions, terrain, and performance expectations in Kathmandu convinced us that there was a good chance of success for an electric autorickshaw. After a followup gathering in Eugene, Oregon, in March of 1994, we offered our services as consultants for the design and implementation of these demonstration vehicles.



Jose Baer with the Lotus Energy Crew.

### The Tempo Driving Cycle Survey

Henning Bitsch and I were hired to do a survey of Tempo driving cycles in Nepal. This would help predict the energy usage, operating costs and performance characteristics for a fleet of 10 prototype electric vehicles. To accomplish this, Henning and I planned to install a multichannel data-acquisition system with a variety of sensors. These were outfitted in two vehicles. One was a stock, diesel-powered Tempo. The other was a Tempo which Jeff Clearwater (Northwest Electric Car) had already electrified. We wanted to discover design parameters from the diesel vehicle's performance *and* see how close the first electric prototype was able to match it.

We used only two sensors in these diesel vehicles. One was an industrial proximity sensor which counted revolutions of the drive shaft. The second was a piezo-resistive accelerometer with its measurement axis oriented parallel to the direction of travel for the vehicle. By feeding the output of both of these sensors into a data acquisition system, we were able to record two time series. The first represented vehicle speed. The



**The Safa Tempo on the streets of Kathmandu**

second represented a combination of both a change in velocity and the slope of the road ( $dV/dt + g * \sin(\theta)$ ). When multiplied by the mass of the vehicle, this second variable becomes the inertial force which must be overcome by the drive train, positive from the motor and negative from the brakes.

The electric Tempo got these two sensors and four more! Both voltage and current sensors were added in the main battery circuit and in the motor circuit. Ultimately, we could obtain enough data to determine the losses in all of the major sections of the drive train—the controller, the motor, and the transmission/differential).

### Off to Kathmandu

After months of delays, I found myself on a grueling flight to Kathmandu in January of '95. Flying from Sacramento to Kathmandu involves three separate planes, stops in San Francisco and Taipei, and a 12-hour layover in Bangkok, all over a 36-hour period with 11 time zones. You can't fly much further from Sacramento. I arrived in the Kathmandu airport at midday (or midnight, I wasn't sure which) with a suitcase full of electronic equipment, and breezed right through customs. Peter had forewarned the customs agent that I would be coming through with a lot of high-tech equipment. It seems that the Safa Tempo project is both famous and popular with the local people.

As I arrived in front of the Global Resource Institute office, I found Henning in a bright red jumpsuit. He was fiddling with a bamboo, wire and duct tape contraption on the right rear wheel of the original Safa Tempo (converted by Jeff Clearwater). "To protect the speed sensor from cows," he explained. Henning had already accomplished quite a bit in the few days prior to my arrival. Most of the sensors were already mounted and functioning, and only required calibration.

Driving in Kathmandu consists mainly of competing with cows, dogs, oncoming traffic and motorcycles for the center of the road while people, bicycles, pushcarts, more cows, more dogs and piles of garbage encroach from the edges. The most important piece of ancillary equipment on any vehicle is the horn, and everybody tests theirs continuously. With all of this action on the streets, nobody ever seems to get up over 45 kmh. Surprisingly, fender benders seem relatively rare. Most intersections are handled without the aid of either stop signs or traffic lights. The few traffic lights which have been installed and are still working are mostly ignored. This turns out to be fortuitous for electric vehicles. With the right combination of timing, willpower and horn honking, it's possible to get across Kathmandu without using your brakes.

I returned home and sketched a design for the ten vehicles to be converted, including it with my January report. Peter reviewed these results and recommendations and hired Henning and I to return in May to supervise the construction of ten vehicles.

## The New Design

The results from our January survey indicated clearly the performance requirements of a standard driving cycle of a diesel-powered Tempo. We calculated that an electric *equivalent* for the same general chassis would involve five things. First, lock the gearbox in 2nd gear. Next, wire twelve 6V golfcart batteries into a 72-volt battery pack. Third, use a 275-amp controller. Four, select a series motor. (We used an Advanced DC K91-4003). And, fifth, use exchangeable battery packs.

The first thing this design did was to rid the vehicle of the clutch and a lot of extraneous and inefficient transmission parts. The original chain-driven reverse assembly was replaced with electrical contactors wired as a reversing circuit. The electric version was more simple and lighter than the mechanical one.

This design also addressed some problems discovered when operating the *first* electric, Safa Tempo. It had been equipped with a 60V battery pack (ten golf cart batteries), a 400-amp controller and the same motor. This battery pack proved to be about 20% shy of the overall range requirements of the Tempos. It was noted that the lower voltage prevented top speed performance requirements with a fixed-ratio drive, forcing the retention of the clutch and transmission. This added both unwelcome weight and hassle. Finally, the motor controller was overrated. All things considered, the first Tempo was not far off the mark and helped with public relations, too.

### The Range Solution? Battery-Swapping!

We implemented a battery-swapping scheme in these vehicles, giving the vehicles a range of 150 km/day with only two swap-outs. Each Tempo would have three SETS of batteries, where a set consisted of two 36V modules. This design made batteries easier to handle and maintain. The project would use sixty 36V chargers in a central charging station where all of the batteries are charged overnight.

### The 12V System

The Tempo's 12V system is handled entirely by the DC/DC converter. This is a significant weight reduction and simplification of the original Safa Tempo which included an auxiliary 12V battery. When the keyswitch is turned on, the 72V battery pack is connected to the input of the DC/DC converter. Its 12V output supplies either the forward or the reverse signal on the contactor set, depending on the position of the Forward/Reverse switch. Four starter contactors and a

control board handle all forward/reverse functions. Initially, the contactor coils are set in parallel, allowing for high-switching force. After about a 1/2 second, the coils are reset into series, reducing the steady state current consumption from the DC/DC converter. This design allowed us to use lower current and, consequently, a less expensive model. The whole assembly is manufactured by Inelco of Denmark. It's a nice assembly for low to medium current applications. The rest of the components are fairly standard and would be familiar to any EV fanatic. The cable, heat shrink, and other components were obtained either surplus or new through Electric Conversions.

### Test Phases and Wiring Harnesses

Between the driving-cycle survey and the construction of the ten vehicle fleet, there was supposed to have been a drive-train design-and-test phase. This phase was to take place in Sacramento with all of the components in a drive-train cycled continuously for a three month period. This would allow us to identify potential problem spots in the design, and fine-tune the charging procedure. A lack of funding and a tight schedule forced us to skip this important phase, and leap right into on-road testing of the ten vehicles. It was a setback but not a show stopper.

"Could you please bring 500 18-22 AWG 1/4" female spades?" This request from Henning one day before I was to leave had me a little puzzled. I knew we might have guessed wrong on the number of connectors, but to be off by 50 of one type in a single vehicle seemed ludicrous. I managed to scrape together 350 before my plane left on Monday morning

The need for 1/4" spades became apparent immediately. It takes a lot of 1/4" spades to re-wire a car. The chassis had arrived from Scooters India with a complete 12 V wiring harness. However, it was of such poor quality that we had to rip it out and start over. This meant re-wiring everything from brake lights to horn. We put together a template for the wiring harness by drawing lines and hammering nails into a 3/4" sheet of plywood. Along with all of the original 12 V wiring, we incorporated some of the 72 V wiring and some additional 12 V wiring our design required. Using the same board, we drew a full-scale setup of all of the high-current wiring for the vehicle. Pictures of the correct lugs and labels were added to each end of each cable. When we got around to assembling the harnesses, the template helped the process go smoothly and error-free.

*We implemented a battery-swapping scheme in these vehicles, giving the vehicles a range of 150 km/day (90 miles) with only two swap-outs.*

The construction crew consisted of Choudry, Krishna (Hat), Ramesh, and Ram (Hat).



Choudry and Ram drill brackets.

Peter Moulton (left) speaks with Krishna (right), who is making the first body.



### Construction Starts

Soon, I was off to Kathmandu for the 2nd time in less than six months. (I hadn't realized that EVs could take you so far from home!)

I arrived in Kathmandu to a slightly different scene than I had anticipated. We were expecting a covered workshop—the plan called for assembling all ten vehicles at once in a batch process—but Peter had not been able to find an appropriate work space. Instead, he had opted to expand his brick patio, convert the servants' quarters into a workshop, and provide us with a one-car garage as additional workspace. Even though the total number of vehicles had been whittled down to seven (three would be completed after our departure), the space was cramped and we had no hope of doing all of the vehicles at once.

Fortunately, by the time I had arrived, Henning had already managed to get one of the vehicles running. He used six of the 12V starter batteries which had come with the chassis. This was a real morale booster for the Nepali crew (Krishna, Ramesh, Choudry and Ram) since the shipment of traction batteries were not to arrive for another 2-1/2 weeks. As a result, wiring harnesses, cable lengths, adapter plate, transmission modifications, and component layout were tackled and completed. All that remained was refinement and replication—and bodies, battery boxes, and chargers.

### Battery Charging

The charger we chose was originally designed for the City-el vehicle from Denmark. It has been tested in thousands of vehicles throughout Europe, and it incorporates all of the features we felt were necessary. It is a three stage charger (bulk, equalize and float) that incorporates temperature correction on its measurement of the gassing voltage and varies the length of the gassing period according to the time spent bulk charging. We had the transformers and control boards for this charger shipped directly to Kathmandu and assembled them there.

Probably the most critical factor in determining the operating costs and utility of a fleet of EVs is the charging cycle. There is a fine line between overcharging and undercharging a lead acid battery which must be found on each charge cycle. In a fleet situation, where vehicles see the same usage each and

every day, it becomes easier to strike that balance. We chose a charger which would make seasonal adjustments automatically. As well, it would allow us to make more general adjustments should we find them necessary at a later date.

Working conditions in Nepal are difficult to describe. Henning had brought a wire-feed-inert-gas arc welder with him from Denmark (donated by Migatronics). That it's the FIRST MIG welder in Nepal gives you an idea of the type of equipment locally. The manufacturing techniques are as antiquated as the equipment. For example, we needed to make 60 battery boxes to be interchangeable. We had no welding table. So, I welded together a jig onto the back of one chassis to make these boxes. The Nepali workers were really impressed. They had never seen a jig which allowed you to make the same thing over and over again! Even though each and every diesel Tempo in Kathmandu has virtually the same body on it, there is no pattern from which they are made. The plans exist only in the heads of the craftsmen who create them.

Our body-making shop consisted of a dirt lot with a few hundred square feet of covered shed. Here was a pile of quarter panels and cab roofs, the only two pieces which come stamped from India. Another pile contained sheet stock to be used on the rest of the vehicle. Krishna, the welder, had a stick welder made from a transformer housed in a plywood box, a couple

of C clamps, a pair of tong-like pliers, a hammer, and a chisel. These were the tools of the trade. This welder turned out to be a pretty versatile tool in his hands. He could perform spot welds between two sheets of thin metal by holding them briefly between the two leads, making a very nice resistance weld. He would repeat this every inch or so, then run a bead along the pieces that were held together. Corrugations to stiffen the body were made with a hammer and pieces of wood on the dirt lot. The structural frame was welded together from small pieces of square steel tubing. The result was impressive and relatively cheap. A complete, painted body is \$450.

The batteries arrived two days before I was scheduled to leave. I believe that an EV should be designed around the battery, but here I was with seven nearly completed EVs and I hadn't touched a battery yet! Considering their journey, the battery pallets looked in pretty good shape. They had been shipped from Trojan Battery Company in Southern California to Calcutta, trucked from Calcutta to the Nepal border (one broken axle and one flat tire along the way), and transferred to two smaller trucks (25,000 lb. is too much for a single vehicle in Nepal). Overall, it took three months for them to reach Kathmandu. We borrowed a forklift from USAID but it tore up the new brick patio, so the other nine were unloaded by hand. Nepal labor is cheap.

With two days left in Nepal, I had just enough time to charge a set of batteries. After three months in the heat, the batteries were at about 1.250 SG (specific gravity). I grabbed Jeevon Goff of Lotus Energy (a local PV installer and inverter manufacturer) and we set out on a two-hour joy ride around Kathmandu. Jeevon speaks excellent Nepali. When we wanted to do grade-ability tests, we were able to pile on a whole bunch of passengers at the bottom of the steepest hill in Kathmandu. Everybody got a kick out of that and the vehicle tested out fine.

After two hours of driving, we called it a night. The Curtis gauge indicated the vehicle was only discharged 20-30% after 45 km. With no body and only two of us on the bare chassis, the vehicle was underweight. Combined with very few stops, we went much further than the 50 km design weight.

The next morning the batteries all measured 1.280 SG (fully charged) and the voltage and current profiles which I recorded during the charge looked good. The system checked out and I still had a day to spare!

Next time you happen to be in Kathmandu, make sure you ride in a Safa Tempo and send me a picture. I'd like to see how the paint job turned out!



Jose and Henning take the electric Tempo for a cruise through Kathmandu.

#### Access

Jose Baer, Blue Heron Design, 4625 P Street, Sacramento, CA 95819. Tel/fax: 916 452-4850.

Jeff Clearwater, Northwest Electric Car, 4343 Biscay St. NW, Olympia, WA. 98502. Phone 360 866-2690.

Electric Conversions, 215 14th St., Sacramento, CA 95814. Phone 916 441-4161 Fax 444-8190.

Global Resource Institute, Baluwatar GPO 7057, Kathmandu, Nepal. Phone 977 1 410357, Fax 777 1 417 205.



## Solar, Wind and Hydro Power

Solar Village Institute Inc.  
Call free 1 (800) 376 9530

From System Design to Installation ✧  
Renewable Energy systems for your home, RV and lifestyle

Ready to install:  
Trace SW 4024 Inverter  
STABER system 2000  
Washing Machines  
SUN FROST REFRIGERATORS

Consultation  
Site Survey  
Installation

Located in NC



## EXELTECH INVERTERS

camera ready  
on negative

black and white  
7.2 wide  
4.6 high

## BACKWOODS SOLAR ELECTRIC SYSTEMS

**For an Earth Restored and a World at Peace... Independent Electric Power Systems for the  
Remote Home—Solar Electric, Wind, Hydro**

We are a family business, living with our products for over 15 years, and offer the knowledge to help you set up your energy system. Free Consultation. Questions are personally answered.

Our catalog includes a planning guide to help you understand how to put your energy system together - its applications and sizing. We offer lower than usual prices on *Kyocera*, *Solarex*, and *Siemens* modules and *Kohler* generators.

Our *Trace* inverters include free battery cables. We carry *Sun Frost* and *Nova Kool* refrigerators, specialized appliances and lighting, and a range of meters and controls: *Heliotrope*, *SCI*, *Ananda*, *TriMetric*, and our own *Backwoods* control boxes.

Our \$3. Catalog/planning guide is FREE to *Home Power* readers.

We accept VISA and MasterCard

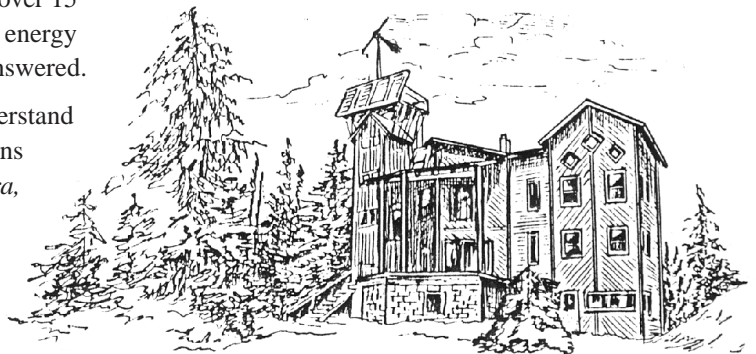

*Most items in stock for immediate shipment.*

**Steve & Elizabeth Willey • 8530-HP Rapid Lightning Creek Road • Sandpoint, Idaho 83864 • (208) 263-4290**

# Sojourns with Shawk

Shawk sips sunlight via two tracking PV modules.

Michael Hackleman

© 1995 Michael A. Hackleman

**K**nowing that I would be up at Agate Flat awhile on assignment, I decided to ask Ely Schless if I could borrow Shawk, his electric motorcycle. This is beautiful country with roads that will eat up your vehicle right before your eyes! So, Shawk seemed an ideal way to get up and down the mountain, thread the ruts and ridges, and just generally explore the area. Mostly, I liked the idea of powering Shawk on a cocktail of sun-juice and wind-watts.

Ely agreed to the loan, so we hauled Shawk out of storage. While Shawk had a proven range of 20 miles at 40 miles per hour on the streets, its batteries were now four years old!

Bob-O Schultze (of Electron Connection) transported Shawk in his pickup truck from Ashland. I walked down the mountain, wrangled Shawk back to terra firma with Bob-O, and headed up the hill.

There was a BIG question mark about Shawk's ability to climb almost 1000 feet over seven miles of backroad in its present condition. Surprisingly, Shawk *just* made it. I had to pause a few times on the last steep grade, but made it up to the plateau. That's trick #29, or "Batteries under heavy discharge will replenish themselves after five minutes of rest." A little patience on my part, *twice*, got me to Agate Flat.

With still more than a mile to go, I drove ultra conservative, implementing trick #13. "Accelerate to speed A and release throttle. Allow a 2 mph drop in speed (to Speed B). Accelerate back up to speed A. Repeat AB." Under light load at speed, series motors aren't doing much with the electricity they use. It takes a while for a 400-pound machine to slow down in its speed by 20% *if* it's electric!

I used another ploy to get up the last two small grades (trick #79, added to the list at Agate Flat) I can *not* push a 400-lb machine up a hill, even a dead electric.



But, walking alongside Shawk reduced the overall weight (and load) by 30% and it powered itself up the hill. Officially, trick #79 is "Get off (or out), apply throttle, point, and maintain pace." It's important to remember the brake's location. The key word is *maintain*.

While Shawk's battery charger plugs right into the 120 vac setup here at the HP offices, the combined inefficiency of battery-inverter-charger was eating big amps. I spied a two-module tracking PV array down by HP's well that was between jobs. I made up clips that would let me plug *half* of Shawk's battery pack (24V) into the two 12V PV modules wired in series. While it's usually a major no-no to recharge packs by portions, I pay attention to it, and the pack seems balanced.

After an excursion, if Shawk's batteries show any sign of being very low (80% down), a full recharge seems to take about two days of sunshine (a sunny day for each side of the pack). Computation says it should take longer. One day at 2 amps should not recharge a 35-aH, sealed lead-acid battery. This is partially explained by Shawk's batteries. They are past their prime and

entering a spiral ending in recycle time. (You could say I've already put them out to pasture.) Also, the sun up here is *strong* and *long*. The array is at 90% output for easily 8 hours, with more than an hour of sun-trickle at dawn *and* dusk. Hey, maybe Shawk just likes the "juice" that comes from the sun!

My *favorite* use of Shawk is for trips to Jenny Creek. Wow! This creek has a 60-foot long section in which I can swim without grinding against bottom, boulders, or shoreline. Jenny Creek is a very cool place, real picture-postcard stuff. (Richard and Karen Perez were married there!) It's two miles away, and mostly uphill coming back.

To and from Jenny Creek, I've yet to get stuck out (in a place where *stuck* really means something!). I come up on a lot of animals in Shawk, since its electric drive is virtually silent. It's hard to sightsee, though. The road is very bad and demands a lot of my attention. Consequently, I also walk the same route. Some days I look away from the computer screen and see the day has slipped away. If I feel a yearning for a cool swim, Shawk is just the ticket to ensure I get home before dark.

Everybody up here seems to like the idea of an electric motorcycle. Moreso, when they see Shawk accelerate. With its 6.5HP series motor, it's strong off the line all the way up to 40 mph (6-7 seconds?). Hills are *not* a problem. The twist-grip throttle terminates in a stock potbox that gives good low-speed handling of the controller when I have to creep up a rock terrace that pretends to be a road. Still, Shawk has proven handy for taking a key down to the lower gate (several miles



All photos: Michael Hackleman

**Shawk is perfect for deep ruts and rocky terraces. The lack of a hot muffler in Shawk means no fires in the high country.**

away) to let someone in (or out). The poor condition of its batteries prevents an immediate round-trip *all the way* down the hill. When I spend a few days in Ashland, Shawk gets an intermediate charge at Bob-O's and is ready for "the hill" when I get back.

For some reason, folks up here think Shawk needs more suspension and wider tires. I wish they could see what I routinely wade through. Ely buried some trick (and expensive) suspension in Shawk. This motorcycle frame (with an engine) has won some major motorcycle races in its time!

Does Shawk need wider tires? These tires grip and let me ride through deep ruts, too. I know there's little latitude for attempting something really dumb. For example, after a cloud burst or long period of rain, I just wait to use Shawk. These roads have sections of black adobe mud and *nothing* trespasses without major

### Shawk Specifications

**Chassis/Frame:** Honda Hawk, race-modified from stock (400 lbs) to 300lbs w/race engine and 380lbs w/electric motor.

**Motor:** Advanced DC Motor, series-type, rated 4.3 HP (continuous), 36-48VDC.

**Battery Pack.** Four, sealed, 35-aH, absorbed glass-matte, lead-acid batteries.

**Controller:** Curtis PMC mosfet (electronic) controller, rated at 350A and 48VDC. The potbox is connected directly to the bike's throttle cable.

**Drivetrain.** One gearbelt connects a 12-tooth gear on the electric motor and a 51-tooth gear on the rear wheel. Overall ratio of 4.25 to 1 is just right. Acceleration is better than a 250cc motorcycle and continues up to 40mph.

**Accessories:** No tachometer, speedometer, or battery gauges. Longest run is 10-mile round trip that used city streets—stop and go and strong accelerations—with battery power remaining.

**Charging.** With utility power, Ely uses four chargers — one for each battery. The output of the Todd chargers,

rated 12V and 25A each, are terminated in a tough 8-pin plug that fits into a flush-mounted receptacle on the bike. At 70% DOD (depth of discharge), the Shawk is 70% recharged in an hour, and fully topped off after 3-1/2 hours. (See text for performance when charged with sunshine and wind.)

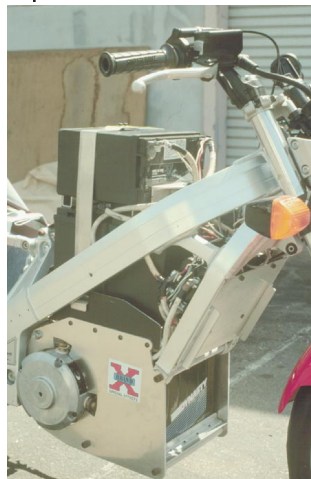

**One battery sits in front of the motor, two are stacked above, and a fourth is set on its side above them.**

After a swim in Jenny Creek, I'm ready for quiet transportation.



slippery-slidey. Organic grease. I think I set (gently dropped? elegantly lost?) Shawk maybe four times in the mud before I got the message. At these times, I've cursed the high positioning of the batteries in Shawk. It took me repeated attempts to get the motorcycle upright. So, a winter bike this is not.

Overall, I've enjoyed using Shawk. It sits out there, plugged in, sipping sunjuice, and waiting for my next time out.

**Access**

Michael Hackleman, POB 63, Ben Lomond, CA 95005.  
Ely Schless, 503 488-8226



**NO-HASSLE WATER POWER**

If you have a reasonably fast running stream or tide nearby and 12" of water clear, Aquair UW Submersible Generator can produce 60 to 100 Watts *continuously*, up to 2.4 KWH per day. **NO TURBINES, NO DAMS, NO PIPES!** Water speed 5 mph (brisk walk) = 60W. 8 mph (slow jog) = 100W. Timber, rock, or natural venturi increases output.



**Jack Rabbit Energy Systems**  
425 Fairfield Ave.  
Stamford, CT 06902  
(203) 961-8133  
FAX (203) 358-9250

12 or 24 VDC

**We Make House Calls!**

**SOLAR ELECTRIC \* SOLAR HOT WATER**  
**\* SOLAR POOL SYSTEMS \***

Serving Virginia, North Carolina, West VA, Maryland

**Tomorrow's World**

1564 Laskin Rd \* Hilltop East Plaza  
Virginia Beach, Virginia 23451

Ph 804-437-8911

Fax 804-437-8051

Sales - Service - Design - Install





## SOLAR QUEST

BECKER ELECTRIC

---

**Wireless Energy Systems**  
CSL #585741 FOR A  
ELECTRICAL CONTRACTING / SOLAR HOT WATER FREEZE

**NEW** Product Catalog PROTECTED  
**\$ 3.95** SOLAR WATER

Photovoltaic SKYLIGHT HEATING  
Skylight roofing Panels SYSTEM  
Energy Efficient SOL-PERPETUA  
Appliances  Wireless Self-Pumping  
Water Pumping  No Moving Parts  
Car Charging Stations  No Electric Running Costs  
Solar Electric  Easy Installation

Solar Electric Systems Residential/ Commercial  
**SALES \* INSTALLATION \* SERVICE**  
11743 Maltman Drive, Grass Valley Ca. 95945  
Phone (916) 477-7645 Fax (916) 477-5631 Orders 800-959-6354



Sol-Perpetua Bubble Pump weighs 4 lbs.

**Positively Electric Videos**

See the Vehicles! Meet the Builders!  
THREE videos to choose from:

**-ELECTRIC VEHICLES-**

Solar Cars • Human Electric • Scratchbuilts • Electrathon  
• Conversions • Proof of Concept • Electric Racers (54 minutes)

**-PANTHER ELECTRIC PROJECT-**

Junior High students build an Electrathon racer and narrate. (18 min)

**-SHOPPING CART RACERS-**

In a dark warehouse, electric and human-powered shopping carts compete for the Golden Caster. A riot of fun! (45 min)

**-Rental (2 wks-\$7) or  
-Purchase (\$22)**

Send \$22 deposit to:  
Michael Hackleman  
POB 63, Ben Lomond, CA 95005

or (purchase only)  
**-ALL 3 (2-hr VHS) (\$47)**



# Join us and get your hands-on!

**Learn the practical use of solar, wind and water power.**

**Hands-on workshops in Carbondale, Colorado in the heart of the beautiful Rocky Mountains**

- Solar Home Design                      October 9-13
- Adobe, Rammed Earth & Straw Bale      Weekends - October

Solar Energy International is a non-profit, educational organization. Membership (\$30) includes a subscription to *Home Power*® magazine.

Call for our Spring 1995 Workshop Schedule

## Solar Energy International

Renewable Energy Education and Sustainable Development  
BOX 715, CARBONDALE, COLORADO 81623  
(970) 963-8855 • FAX (970) 963-8866

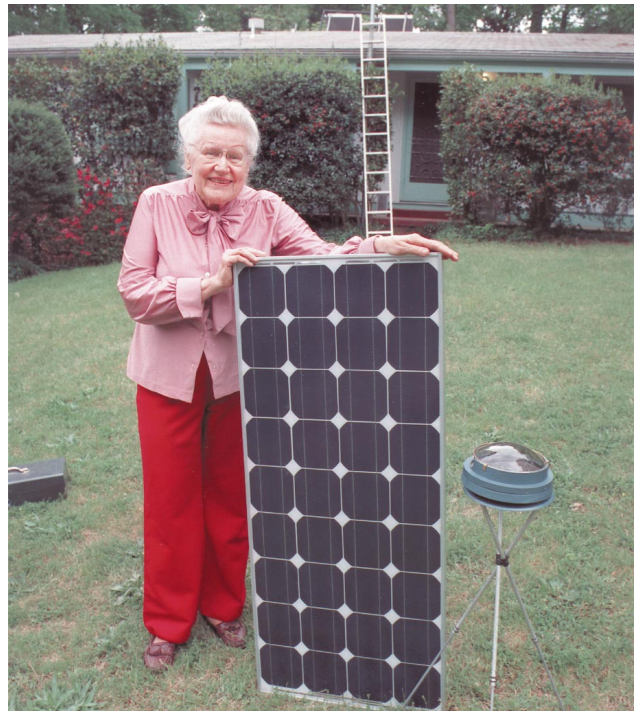

## Electricity From The Wind & Sun



Utility Intertie Systems. (The 1st in the UK)

**Stand Alone  
& Remote  
Home  
Systems**

**UK  
Distributors  
for Home  
Power  
Magazine**



**11 years experience; our office, showroom, and workshop are wind & solar-powered.**

Marlec, Wind Baron, Proven, Bergey and Vergnet wind turbines; Siemens, BP Solar and Solarex PVs; Powerstar, Trace, ASP sine wave and SMA utility intertie inverters; Oldham and Exide batteries. Also: Wattsun Trackers, APT Powercenters, ShurFlo pumps, low voltage lights, appliances and much more.



### Wind & Sun

The Howe, Watlington  
Oxford, OX9 5EX  
United Kingdom

TEL. (44)-1491-613859

FAX (44)-1491-614164



**Send for our Design  
Guide & Catalogue:  
Price £5.00 in the  
UK (add £1.00 for  
overseas postage).**

The Saga of Shopping Cart Racing—Part Two

# WILD CAT ONE

## Design and Construction

Clare Bell

©1995 Clare Bell

**B**ehind the adventures of Wildcat One is the core of a practical machine. The modular drivetrain contained within is simple enough for backyard builders to build and fast enough to power a shopping cart racer. It can also be configured as a little garden tractor. It is simple, inexpensive and easy to repair. Want one?

You got your first glimpse of Wildcat One in the last issue (*WildCat One: The Saga of Shopping Cart Racing*, HP48, pg 52-55).

Wildcat I consists of two articulated units: a traction (drive) unit that pulls and a trailer where the driver sits. Dual footpedals control drive motors on each wheel in the tractor. So, there are two identical (though mirror-imaged) independent subassemblies. Each subassembly is comprised of a footpedal, motor, V-belt, belt-tensioning mechanism, and framework that supports an axle. Each footpedal is equipped with a toe-switch accelerator (motor contact) and a heel brake, with a V-belt drive pulley. Since the footpedal and motor assembly are mounted on a pivot, toe pressure not only closes the motor contact (full power to the motor) but also increases the tension of the V-belt. Liking slipping a clutch, the V-belts grip with



Clare Bell with Wildcat One.



Otmar Ebenhoech on "Bunnies". Rubbing alcohol injected onto the tires and ignited with an auto ignition coil yields flames. Looks very cool in a dark warehouse.

increased tension. The result is a simple, continuously-variable mechanical transmission.

Steering, then, is basic. It is a matter of articulating the two units about a hinge pin! You won't need strong arms to do it. This unique electric drive train is designed to help power you through nice, sweeping, shallow turns. Want a tighter turn? *Power* the outside motor while *braking* the inside one. This requires some coordination, but once mastered, it gives unbelievable cornering capability.

If you want to design and build your own version of the vehicle, the photos and drawings will give you an idea of what's involved. If you decide to build an exact

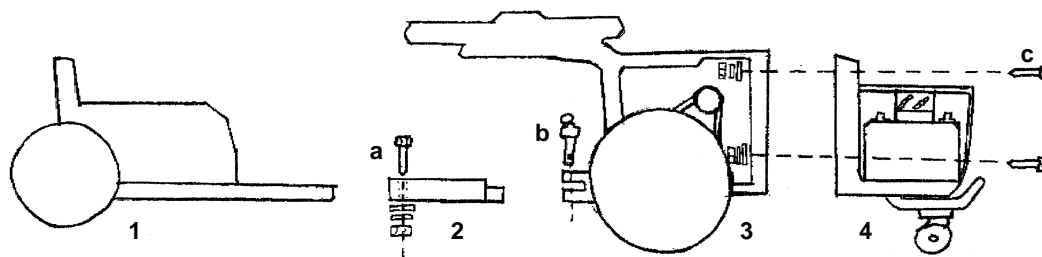

1. Trailer
2. Coupler
3. Drive Unit
4. Power Unit

- a. Coupler bolt, washer, lock, & nut
- b. Hitch pin
- c. Frame bolt, washer lock & nut (4 ea)

duplicate, I've got some additional drawings that will help with parts fabrication. This includes parts-ordering information, and a list of tools and instructions to guide you in fabricating parts and assemblies. Before you do or buy anything, read through this article several times. *Don't skip the overviews or the "important stuff".* You need to understand the vehicle well in order to build it safely and successfully.

**Construction**

To make the task of building a vehicle "from the ground up" less formidable, I have divided it up into major sections. Each of these is then broken down into a series of assemblies, sub-assemblies and individual parts. (The more complex assemblies, such as the V-belt transmission, will be treated step-by-step, with photos, in the next article in the series.)

Wildcat has four major sections: trailer, coupler, drive unit and power unit. The trailer is basically a protected seat with wheels. The coupler is an adjustable-length of square tube with pins at both ends. I'm assuming that back-yard builders capable of doing this project can and will want to design their own trailer and coupler. So, I'll give only a general description to supplement the diagram

This article will focus on the tractor, which contains two drive units (motor, drivetrain, and control) and a supporting power unit (batteries and containment).



Bob Schneeveis is behind the design of Wildcat One.

**Functional Block Diagram: Wildcat One**

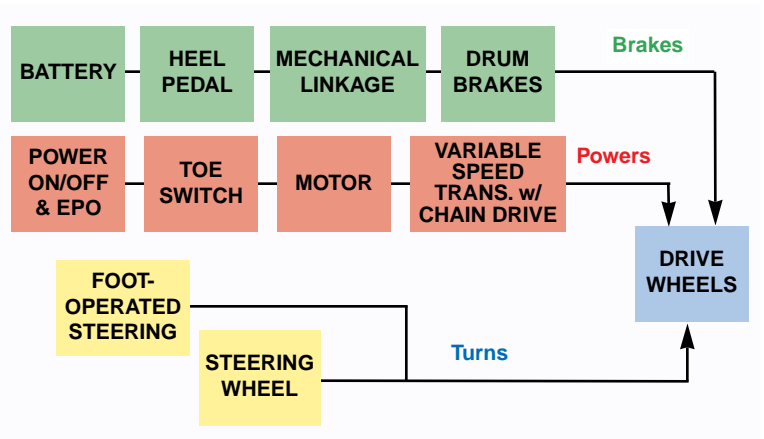

**Note:** A vehicle that switches this much battery power mechanically *must* have a power cut-off and fuse. A simple, hefty knife-switch does just fine. Be sure the base is a non-conductive bakelite or phenolic plastic. You can mount the 500-amp fuse separately or combine it with the knife-switch as done here. If you use the fuse as the knife-switch lever, put a reinforcing bracket on it so that it doesn't break. Fuses aren't designed to take this type of mechanical stress. I've wrapped a large cable tie on the fused knife-switch so I can grab and yank in case of an emergency.



Combined fuse and knife switch.

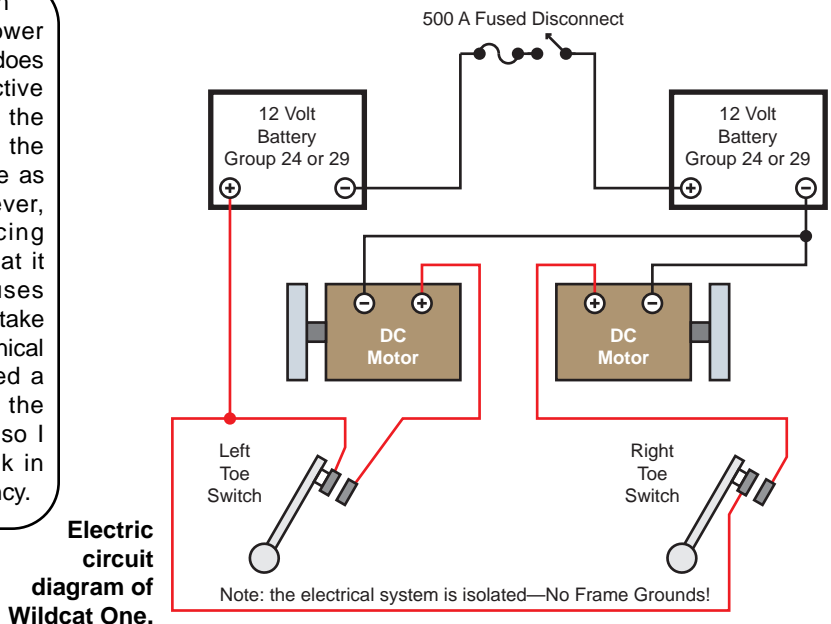

Electric circuit diagram of Wildcat One.

*“... do not install the batteries until you have finished all mechanical and electrical work.”*

### Wiring: Safety First!

1. Leave the batteries out while installing the wiring. If you need to, put them in briefly in order to measure cable lengths, fine. Batteries add significant weight, so the vehicle will be much easier to handle without them **and** you avoid the risk of sparks and shorts.

2. When working around batteries, use eye protection (goggles or face shields). Your eyeballs will be grateful.

3. If you are unsure if a component or terminal is live, check it first with a voltmeter. 24 Volts DC may only give you a tingle, but this is a high-amperage system, so watch out!

4. Install a power cutoff for you vehicle and **use** it while working on the vehicle or installing the batteries.

5. Install lugs on battery terminals tightly or leave them off altogether. Loose or sloppy connections will turn battery terminals into craters surrounded with lead puddles. It's one heck of an adrenaline rush, too.

6. A length of #10 wire can serve as a sacrificial fusible link during the first power-on (this saves expensive fuses). Later, substitute bigger wire.

7. Block the vehicle up during power-up tests. This prevents the vehicle from going ballistic. If the wheels are off the ground, all they can do is spin.

Now you can start building cables and wiring. Refer to the accompanying drawing for all your high-current wiring. Don't undersize these cables. If they're too small, performance suffers and the vehicle is at risk of fire. Only the instrumentation circuits use low-current wiring.

### A Word about Mechanical Loads

Wildcat's dual chain drive exerts a lot of power and thus high stress on supporting components such as frame members and mount plates. The two sprockets must be parallel and aligned in the same plane with each other. Otherwise, the vehicle will tend to throw chains like a mis-adjusted bike derailleur. Make sure the vehicle's frame is strong and rigid. Mounting plates must be stiff and bolted securely.

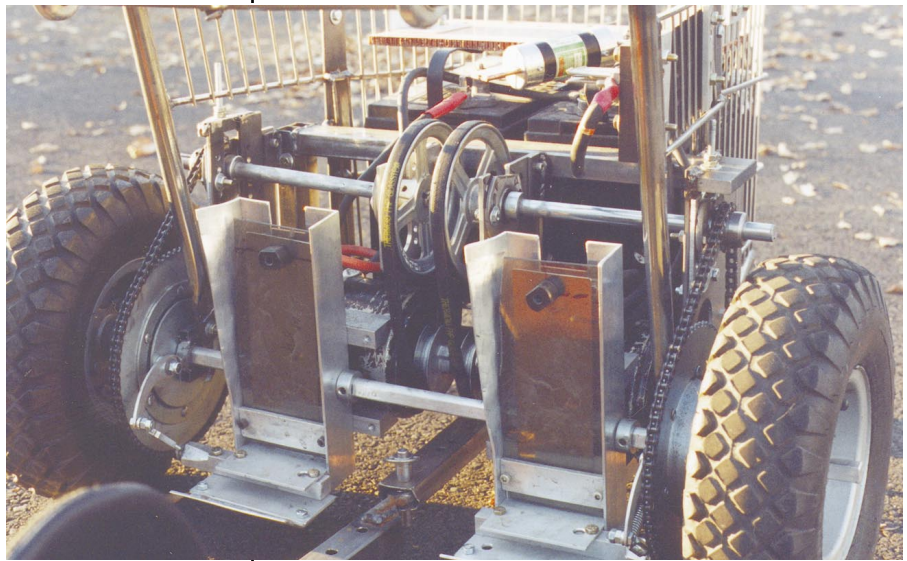

The machinery of Wildcat One

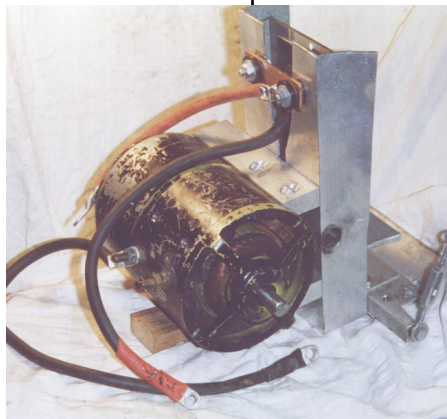

Footpedal motor control assembly

Footpedal switch

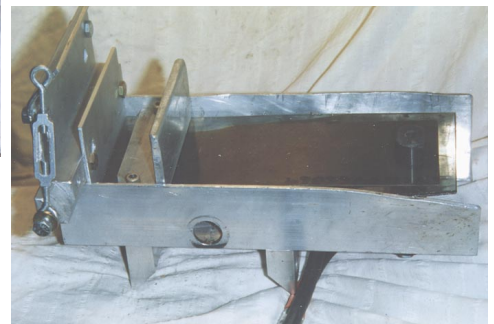



For the same reason, install keys in the milled keyways when mounting sprockets and pulleys on shafts. A setscrew alone will *not* hold against the high torque generated by these motors! Cut keys from key stock.

### A Word about Electrical Loads

Wildcat's electric drive is almost absurdly simple, but there are some important points. Note that the system

is frame-grounded through the motor cases. All connections on the hot side of the motor, therefore, must be insulated. The design does this by using bushings in the footswitch contacts to isolate any current-carrying parts such as the brass bolt and copper bar. A non-conductive flexible Lexan plate keeps the flat spring in the footswitch from accidentally shorting the hot components

### Overview of Drive Unit

Each drive unit breaks down into five parts or assemblies as shown in the accompanying diagram:

- V-belt transmission.
- Footpedal motor-control assembly.
- Drive wheel and sprocket.
- Brakes.
- Chain and chain tensioner.

Each part is separately assembled. As well, both drive units share:

- Front axle/ footpedal pivot shaft.
- Frame.

In more detail:

**V-belt transmission.** This part is composed of a jackshaft assembly with a pulley on one end and a drive sprocket on the other. The v-belts from the motors slip or grip on this pulley, providing the continuously variable characteristic.

**Footpedal motor control assembly.** The motor and its pulley bolt to the footpedal. Each footpedal contains a high amperage contact switch with a leaf spring to keep the contacts open until pressed. Because these parts are connected to the hot side of the motor and must be kept isolated from the frame,

they incorporate insulating bushings and a non-conductive Lexan shield. The heel of each footpedal links to a drum brake.

The motor is rated 24V and 2.3HP. It was surplus, originally part of an air compressor system.

**Drive wheel and sprocket.** The vehicle uses a split-wheel, four-bolt, go-kart hub and tire. Wheels turn on a fixed axle shaft and are held in place by a fine-thread screw, lockwasher and washer at the end of the axle shaft. The drum side of a commercial mini-bike drum and sprocket assembly bolts to the go-kart hub.

**Brakes.** These are mini-bike drum brakes designed to work with the drum and sprocket assembly described above. Each brake has a backing plate that locks against the vehicle's frame to prevent brake rotation. They use an adjustable turnbuckle-type linkage from the brake lever to the footpedal assembly.

**Chain and chain tensioner.** A motorcycle chain transmits power from the jackshaft sprocket of the transmission to the drive wheels. Since chains stretch and loosen with use, the vehicle incorporates a simple chain tensioner for adjustments.

**Front axle and footpedal pivot shaft.** This is a 3/4 inch steel shaft with a flat ground onto it for setscrews to tighten against. The ends are machined down to accept the go-kart hubs. The shaft is mounted to the frame by 3/4 inch shaft collars that are fixed in place (welded or bolted). Then, both footpedal assemblies slide onto the shaft and are held in position by other 3/4 inch shaft collars.

**Frame.** This structure supports all the drivetrain components and must be strong and rigid. Make it from 1 inch and 1/2 inch square steel tubing, cut and welded.

If you don't have access to welding, you can bolt the frame together. The Jergenson box-beam construction method, previously presented in *Home Power*, would be an ideal way to do a non-welded frame.

For a first "build", I recommend that you stick with the original design. Later, you can get creative.

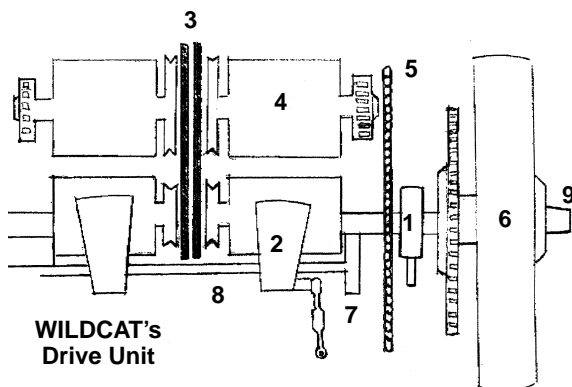

WILDCAT's  
Drive Unit

- |                         |                         |
|-------------------------|-------------------------|
| 1 Drum Brake (2)        | 6 Wheel & sprocket (2)  |
| 2 Footpedal control (2) | 7 Frame                 |
| 3 V-belt (2)            | 8 Footpedal pivot shaft |
| 4 Transmission (2)      | 9 Axle                  |
| 5 Motorcycle chain (2)  |                         |

**The Power Unit**

The power unit is more simple than the drive unit to fabricate. It is composed of battery containment and the batteries themselves.

Since Wild Cat began as a shopping cart, I used the original basket to contain the batteries. The frame was modified to drop the basket right down onto the part of the frame that supports the casters. The basket itself was modified and strengthened to bolt onto the power unit. To stiffen the basket, 2 inch by 1 inch steel tubing was welded underneath the basket from back to front along the midline. This acts as a receptor for the pin hitch, too.

The batteries are held in place with flat material and angle brackets. Bolts and wing-nuts clamp the angles

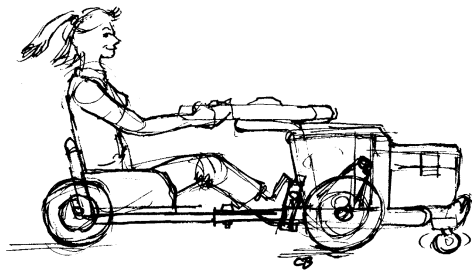

to plates on the outside of the basket, securing the batteries. Wild Cat uses orangeboard composite, but plywood works just as well. Finally, you can fabricate your power unit from Jergenson box-beam and bolt it to the drive unit in the same way.

The battery pack is comprised of two Group 29 (marine-starting) batteries placed side by side in the shopping cart. If you head out on your own, *do not install the batteries* until you have finished *all* mechanical and electrical work.

**Next in the Wildcat series**

The next installment of the WildCat saga will be a photo walkthrough of the fabrication of components for WildCat's powertrain.

**Access:**

Clare Bell 799 36th Ave, San Francisco, CA 415-221-9678. Send \$5 (copy,ship,handle) for detailed component fabrication drawings not printed in HP.

Northern Hydraulics. 800-533-5545, fax 612-894-0083

For notification and info about shopping cart races, send email to [shopcarts@atticus.com](mailto:shopcarts@atticus.com)



**THE TRIMETRIC**

—*quality* and *affordability* in a VOLTS, AMPS and AMP-HOUR meter—

**We want you to buy this monitor for your electrical system!** (Because that's how we make some money!)

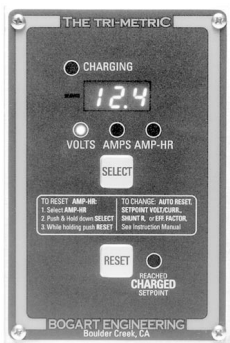

**But that's not the only reason...**

After you've spent thousands for an electrical system, we believe that a monitor will increase your awareness of your battery charge state and electrical usage. This knowledge should translate into longer battery life and smarter usage of your power resource—which could easily be worth an extra solar panel—at 1/2 the price!

That's the *other* reason we made this meter!

The *ideal minimum* battery system monitor for 12/24 V systems  
Call your RE distributor or us for more information.  
Suggested retail \$160 (shunt not included)

**BOGART ENGINEERING**  
19020 Two Bar Road, Boulder Creek, CA 95006  
(408) 338-0616

**THE OLD**



- 1 circulation pump with motor
- 1 differential controller
- 2 temperature sensors
- 1 expansion tank
- 1 automatic air vent
- 1 pressure relief valve
- 1 check valve
- 12' electric wire and fittings
- 30' control wiring
- manual showing a 41 step trouble shooting tree
- electric costs for life weighs 35 lbs.

**THE NEW**

They cost the same.  
They do the same job...  
Ours is fun to watch.



1 SOL-Perpetua Bubble Pump weighs 4 lbs.

- SOL-Perpetua Features**
- Wireless- Self-Pumping
  - No Moving Parts
  - No Electric Running Costs
  - Easy Installation

Prices start at \$450.00

For a freeze protected solar water or space heating system the choice is yours...  
For installation manual and Video send \$20.00 to:

**Bubble Action Pumps LTD.**  
121 Counter Street, Kingston  
Ontario, Canada K7K 6C7  
Tel (613) 542-4045 • Fax (613) 542-0198

Solopower  
b/w  
camera ready  
7 wide  
3.5 high

## Enjoy FREE Heat with Solar Energy!

The Environmental Solar panel absorbs heat from the sun and distributes it up to 150 square feet throughout your home quietly with a thermostatically controlled blower. Environmentally-friendly heating alternatives you can afford. For a limited time only a single panel Was \$280 NOW \$250

- Reduces heating costs
  - Environmentally friendly energy source
  - Simple maintenance
  - \$35 Shipping and Handling in the USA.
- Call or write for a free brochure

## Natural Solar Food Dehydrator!

- Dries herbs, fruits, vegetables quickly & naturally with the sun's energy
- Fun and easy to use. Heavy duty construction.
- Size 22" x 21" Was \$116, NOW \$88 + \$14 S/H also 22" x 45" Was \$165, NOW \$125 + \$18 S/H. sale prices for a limited time only...
- Commercial sizes available too.

**Environmental Solar Systems, Inc. 1-800-934-3848**

119 West Street, Methuen, MA 01844-1325

### SOLAR ELECTRIC WATER PUMPING SYSTEMS

- FOR ALL APPLICATIONS
- STOCK WATERING
  - DOMESTIC WELLS
  - SHALLOW & DEEP

### COMPLETE POWER SYSTEMS

- FOR • HOMES & CABINS  
• FARMS & RANCHES  
• RECREATIONAL VEHICLES

### Generators:

- \* Diesel \* Gas
- \* Propane
- \* All Sizes

If you require electricity and are away from power lines, we can help! Call Mike or Dave at Aurora Power & Design and we'll design a system to fit your needs. WHEN RELIABILITY REALLY COUNTS!

## AURORA POWER & DESIGN

3412 N. 36th St, Boise, ID 83703 Phone (208) 368-0947



## WINDSTREAM®



**WIND GENERATORS FOR CHARGING 12 VOLT BATTERIES**

**ONLY \$497**

FOR COTTAGE, MARINE, RV, TELECOM AND WIND - SOLAR APPLICATIONS

**BUILT TO LAST!**

### WIND TURBINES FOR ALL USES

CONSTRUCTION PLANS, KITS AND ALL PARTS AVAILABLE

### HAND AND PEDAL GENERATORS

MICROHYDRO SYSTEMS

### PERMANENT MAGNET GENERATORS AND ALTERNATORS

### WINDSTREAM POWER SYSTEMS INC.

ONE MILL STREET  
POST OFFICE BOX 1604-HP  
BURLINGTON, VT 05402-1604

TEL 802 658 0075  
FAX 802 658 1098

MANUFACTURING SMALL WIND AND WATER POWER SYSTEMS SINCE 1976

## SNORKEL STOVE

camera ready  
b/w  
3.4 wide  
3.4 high

# Driving an Electric Car

Shari Prange

©1995 Shari Prange

**When driving uphill, you will shift to a lower gear sooner than you would in a gas car.**

**A**n electric car is a beautifully simple machine. Driving it is simple, too. Yet, it is a little different from driving a gas car. You and your electric car should take some time to get properly acquainted in order to ensure a happy relationship.



## Road Test

Don't do your first road test on your Monday morning commute. Pick a time when you are relaxed and don't have to be anywhere on a deadline, and take a little joy ride. If the car has just been converted, the first drive should be around the block, because you are still proofing the conversion itself.

Listen for unusual sounds, and investigate any that seem ominous. After a few circuits, stop and look the car over. Check for anything that may be vibrating loose or rubbing. Be aware of any unusual smells, and check components and connections (carefully!) for excess heat. Anything that gets hot after a few gentle laps around the block needs attention.

## Getting Acquainted

Although we aren't usually consciously aware of it, we are continually monitoring the cars we drive (or we should be). Our brains have a template for "normal", and the car's feel, sounds, and smell are constantly being compared with that template. You need to learn what's normal for your electric car, and build a new mental template.

Any time you change from one car to another, you will notice slight differences in the feel of the pedal action, steering, and shifting. The same is true for your electric car. Experiment to learn how it feels under acceleration, braking, and turning. Once you are used to its normal feel, it will be second nature to you.

In some ways, an electric car is very different from any gas car. The most obvious difference is the sound—or lack of it. The electric car is much quieter than a gas car, and the sounds you do hear are different ones. You

may be startled at first to realize how much you used auditory cues in a gas car without knowing it.

The electric motor does have a faint whine. With a little practice, you will be able to recognize the proper time to shift from the sound of the motor, just as you did in a gas car. The slight clack of the contactor tells you that everything is functioning properly when you depress and release the throttle. The main sound you will hear is the whisper of the tires on the pavement.

All this quiet has another advantage. You will be aware of mechanical problems much quicker than in a gas car. Worn brakes, wheel bearings, or constant velocity joints will be audible at an early stage.

## Break-In

If this is a newly-built car, there are three things on it that will require "break-in". The first is the battery pack. Brand new "green" batteries do not achieve their full potential until they have been through a number of charge/discharge cycles. How many cycles varies with the make and model of battery. Of the most popular brands, the U.S. Battery breaks in more quickly than Trojans. Until that occurs, you will not achieve full range with the car.

The second thing needing break-in is the motor. It will not run at its best efficiency until after about twenty hours of operation. By this time, the brushes are fully seated. After the brushes go through break-in, the sound of the motor will become quieter as well.

The third thing that needs break-in is the driver. As you learn how the car feels, you will develop new driving

habits automatically. After the first month, and battery and brush break-in, you will be a more efficient driver.

### Range and Routes

Before you start using the car as a daily driver, you may want to test its range. (Keep in mind that this will improve dramatically after break-in.)

Before you can test your range, you have to define "out of juice". On a gas car, this is easy: it won't go. On an electric car, however, the definition is more like "it won't go fast enough". You need to choose a definition to suit your driving needs and comfort zone, such as "out of juice means I can no longer maintain 40 mph in second gear on Mulberry Street."

With that established, lay out a route no more than a couple miles long close to home. Drive it normally until you reach your definition of "out of juice", then go home. Learn how the car feels as it gets to the end of its charge, and how your voltmeter or state-of-charge meter reads throughout the drive. If you have explored and experienced the limits of the car's range under safe conditions, you won't be afraid of running out of juice in daily driving.

Next, start driving the car on your normal routes when you aren't under time pressure. Drive your normal commute route on a Sunday. Pay attention to hills, stops, and traffic flow, and think about whether an alternate route might be better. Sometimes the quickest or most efficient route isn't the shortest or most direct.

### Shifting

Most conversions use a clutch, for reasons of both safety and comfort. It's used pretty much the same way as it is in a gas car, with a couple of small exceptions.

Although you don't need to use the clutch to start from a dead stop, it will give you a smoother take-off. As you start, the ammeter will peg briefly, then begin to fall off as speed increases. At some point, it will stabilize. You have reached peak performance in that gear, and it is time to shift up if you want further acceleration.

You can also calculate the "red line" shift points for each gear and mark them on your speedometer. With the Advanced D.C. motors, these points will be very close to the car's original recommended shift points. The formula for calculating these is:  $MPH = (RPM \times R) / (G1 \times G2 \times 168)$ . MPH is the maximum speed for that specific gear; RPM is the rated motor rpm at your pack voltage; R is the rolling radius of the drive wheel tires in inches; G1 is the gear ratio for that specific gear; G2 is the final drive ratio; and 168 is a constant.

The motor runs most efficiently toward the top of its rpm band. For example, say the red line for second

gear is 45 mph. At 40 mph in third gear, you will be pulling about 60 amps more than 40 mph in second gear. The moral is, don't over-rev your motor, but don't lug it, either. Learn where the "sweet spot" is.

On uphill, you will need to downshift earlier than you would in a gas car. Climbing a hill in too high a gear will overheat your motor and controller. You will be able to feel the power fall off as you climb, and that's when you need to shift down.

Conversely, on downhill, you need to shift up. When you top a hill in a low gear and start coasting down, you will pick up speed quickly. If you leave the car in the low gear, you can over-rev and destroy your motor.



**At 40 mph in 2nd gear, the ammeter reads 180A. This is the most efficient gear for this speed.**



**At 40 mph in 3rd gear, the ammeter reads 240A. Note that the greater load drops the needle on the state-of-charge gauge.**

### Braking

On long downhill, without dynamic braking from the motor, you will need to use your brakes a lot, much as you would in an automatic transmission gas car. It is better to pump the brakes from time to time than to hold them down. Holding them down can quickly cause them to overheat and lose effectiveness.

### Gauges

We mentioned the ammeter a little already. Let's look at what your gauges tell you. Your ammeter is an efficiency gauge. You want to keep it as low as possible for maximum range. It will quickly tell you which gear is the most efficient for your speed and grade.

Typical ammeter readings are: 400 for momentary acceleration from a stop; 100 cruising on the flat; 200 on a slight upgrade or at high speed; 300 on a steep grade; and 0 when coasting.

A pack voltmeter or state-of-charge gauge will vary inversely to the ammeter. As the ammeter climbs, the voltage gauge will fall off as you "draw down" the pack. As soon as you let off the throttle, however, the voltage

gauge will pop back up. For this reason, you can only get a true reading on your pack voltage or state-of-charge when you are stopped or coasting. However, with practice you will quickly learn what is a "normal" reading for your car at any particular point in your typical route, even under power.

**Reserve Energy**

An electric car has a built-in reserve fuel supply. When you stop the car, you will notice the voltage gauge starts to creep upward. When you come out of the grocery store, the car may show 10% more charge than when you parked it. Batteries have the capacity to "grow volts" to a limited extent just by resting.

What this means in real life is—if you miscalculate and run out of juice, you can pull over and let the car rest for a few minutes. You will regain enough charge to let you drive another couple of miles. Although this isn't recommended as a standard practice, you can do it several times in succession if necessary to get home. Let's see a gas car "grow gas"!

**Efficiency Tips**

During the gas crises, we were all told how to drive our gas cars more efficiently: gradual starts, moderate speeds, watching traffic flow, etc. All of these things will

also improve the range of an electric car. However, you can take advantage of some of the differences in an electric car to extend your range as well.

One, if you have properly inflated low rolling resistance tires, your electric car will roll nearly forever. Use your downhill momentum to carry you up the next hill. (This is a more efficient use of the energy than regenerative braking, by the way.) Don't automatically hit the throttle just because the road rises a little. Let the car tell you when it needs more juice. You'll be surprised how briskly it can roll up a slight grade.

**First**, when approaching a stop, let off the throttle much earlier. Unlike a gas car, the electric car will coast a block or more with no throttle, and with little loss of speed until the end. **Second**, monitor the ammeter. Sometimes a slight reduction in throttle will save you 50 amps, with no perceptible loss in speed. And, **third**, as in any relationship, the most important thing you can do is really listen to your partner. Your car will tell you how it performs best. Get to know your electric car on its own terms, and enjoy the benefits of its differences.

**Access**

Shari Prange, ElectroAutomotive, PO Box113, Felton, CA 95018 • 408-429-1989





CA Lic. #661052  
**Our Eleventh Year Offgrid!**  
*We will meet or beat any other company's prices.  
We provide excellent service and technical support.*

 **TEAM SOLAVOLT**

Residential Power • Water Systems • Phones • All Major Brands • Wind  
• PV • Hydro • Custom Design • Installation • Mail Order  
**Workshop on the Basics of Residential PV**  
October 22 - \$35  
Call for information and directions  
**(209) 877-7080**  
*located in the central Sierra,  
near Yosemite*



**OFFLINE**  
P.O. Box 231  
North Fork, CA  
93643

We'll Send You Our  
**CATALOG**  
for  
**\$3**

## WARNING:

DON'T BUY YOUR PV SYSTEM UNTIL YOU READ THIS!

**Did you know not all PV dealers are the same?**  
Not all dealers offer free system design. They haven't all been around for 15 years. Most don't even have a full-time engineer on staff. Many don't carry all the popular brands, only a few. Not all sell other energy efficient products, including lighting, gas room heaters, tankless water heaters, propane refrigerators, and a large selection of books. Most don't have a comprehensive 140 page design guide/catalog. Which makes it all the more amazing that there is ONE DEALER that offers you all this and MORE. We've been in PV for over 15 years, and we have what you need. For our 1995-96 140 page design guide & catalog, send \$5 (credited to 1st order) or call our toll-free number. Credit card orders OK.

**Sierra Solar Systems**  
(formerly Integral Energy Systems)  
109H Argall Way Nevada City, CA 95959  
Phone: 800-51-SOLAR Fax: 916-265-6151  
e-mail: solarjon@oro.net

**BACK HOME MAGAZINE**  
 camera ready  
 black and white  
 2.875 wide  
 5.7 high

**LIGHTING FOR YOUR EVERY NEED**

Using **NEW STYLE Compact Fluorescent Bulbs**

Instant on, no flicker!

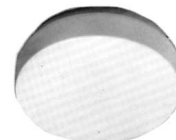

DC available in 12, 24, 36 and 48 Volts

AC 120 and 220 Volts

Indoor - Outdoor

Quick-Fix retrofits

Decorative Household

Task

Recessed



COMPLETE LINE OF SOLAR PRODUCTS AVAILABLE



DEALER INQUIRIES WELCOME

For more information please call or write:



**ALTERNATIVE ENERGY PRODUCTS**  
 RD3 Box 312  
 Putney, Vermont 05346  
 Phone/Fax (802) 722-3704

**PHOTOCOMM**  
 black and white  
 camera ready  
 4.5 wide 3.55 high

**AIM YOUR  
 PHOTOVOLTAIC  
 PANELS AT THE SUN...  
ALL DAY, EVERY DAY**

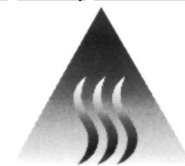

**American SunCo**

FREE

Information package on

**Sun Tracker 8**

PV Tracking System

- Provides 40% more power
- Accurate even in wind/cold
- Reliable
- Affordable
- Warranteed

**American SunCo**

PO Box 789H, Blue Hill, ME 04614

**(207) 374-5700**

# A Visit to a Battery Factory

Steve McCrea

**M**y love affair with electric vehicles began when my dad let me steer a golf cart. I was six. I was fascinated with the hums, whines, and squeaks that came from a vehicle powered by black boxes. Something magical happened inside the golf cart's batteries, but I soon lost that early curiosity.

Years later, I rode in the CommutaCar in Sebring, in dozens of near-production models at EVS-12, and at numerous car rallies. Still, I never gave the batteries much thought—until I began compiling the first edition of *Why Wait for Detroit: Drive an Electric Car Today*. I asked various authors to contribute articles about how to convert, where to buy, and how to efficiently drive an EV. Several EV pioneers were willing to share their findings about what batteries performed best. Still, no one outside of a battery company could show me how a lead-acid battery was made.

In February of 1991, I traveled to Troy, Alabama to investigate lead emissions when batteries are recycled (see *A Visit to a Lead Recycling Factory*, HP#48, page 64-66). Then, I took a side trip into Georgia to visit US Battery Company's manufacturing plant.

## The Tour

The 6-volt batteries made in this factory were destined exclusively for use in golf carts. This explains why the foreman who gave me a tour of the facility was puzzled when I explained that I hoped to be driving an electric car on the highway soon.

The process starts when lead reclaimed from old batteries (most of it from the Troy, Alabama smelter) is converted into lead oxide paste. Lead grills hold a layer of this paste which is baked-on in a conveyer oven to form a "plate." These battery plates are then welded into 2-volt sections. Three sections are welded together to make a 6-volt battery. As I watched this process, I knew that I would have been interested to see this process and the guts of these magical black boxes when I was six.

©1995 Steve McCrea

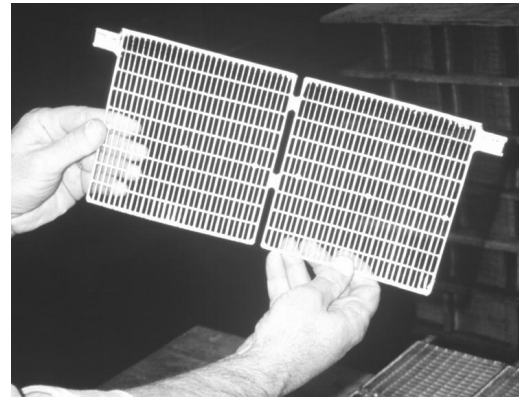

The lead grid of a typical 6-volt battery.



Lead-oxide paste is baked on the lead grid in an oven.



Sandwiches of lead-paste-and-grid form three 2V cells.

Workers wear facemasks to reduce exposure to lead dust.

Workers who inspected the lead-paste plates wore breathing masks, so I wondered aloud about my own safety. "There's more lead dust in the air in a major city than in here," my guide explained. "Large bag filters remove so much lead dust that the air leaving the factory is cleaner than when it enters."

Yes, there is a small amount of airborne lead that escapes from the factory. And, yes, workers need to protect themselves as the batteries are filled with acid, sealed, and given a charge before shipment to a



## The Lead Herring

### A New Attack on Electric Cars

Dr. Richard Komp

©1995 Richard Komp

Over the years, a number of "red herrings" have shown up in the renewable energy field. Examples include "solar cells contain poisonous cadmium" and "wind generators kill birds." Of course, these "red herrings" are either not true at all or a gross exaggeration of a very minor problem put in the way of a technology that poses a possible threat to the status quo.

The latest of these is an article that appeared in a recent issue of *Science* Magazine [L.B. Lave, C.T. Hendrickson, F.C. McMichael, *Science*, Vol. 268, 19 May 1995, pp 993-995]. Titled "Environmental Implication of Electric Cars," the article examines the amount of lead that would be released into the environment if we started using electric vehicles (EVs) in any quantity. Their conclusion is that an EV, over its lifetime, would release more lead into the environment from the manufacturing and recycling of the storage batteries used in the car than a very efficient gasoline powered car would release if it used leaded gasoline. Upon careful reading, one discovers that a series of extremely pessimistic assumptions are needed to reach this conclusion. First is the 45 mile average driving range of the modern EV. This must be amusing to the American Tour de Sol teams who pulled into Portland last Friday after cruising well over 100 miles on a single charge some racedays. Second is the 20,000 miles between replacement of the car's entire battery bank. Reports from users of home-converted EVs give lifetimes two to three (2-3) times that number. Third is the amount of lead lost in recycling lead-acid batteries; given as between 2% and 4% of the total lead processed. And finally, the assumption that all the lead lost ends up in the atmosphere. Even the authors comment that this may not be so.

One very definite conclusion can be drawn from the article: The lead industry is still dirty at the moment and needs to clean up its act. Many lead recyclers are located in "Third World" places where environmental controls are either nonexistent or ignored. I've heard stories about plants in Taiwan and Mexico poisoning whole villages. Even if the vested interests win and we have no EVs in the future, we recycle an estimated 40 million batteries per year in the United States from the

internal combustion automobiles we drive now. Using the author's numbers, this amounts to 20,000 tons of lead lost each year.

However, very little of that may end up in the air. In fact, a lot of the loss may be in the form of entire batteries that "evaporate" out the back door of the recycling plant, just to come back in the front door after being rebought for the scrap lead. I don't blame a Mexican peasant who supplements his miserable income with a lead bonus or two. In any event, 20,000 tons is a good size lead mine and most of this mineral wealth should be within yards of the recycling plants and readily recoverable.

One more point brought up in the article has nothing to do with lead but is a "red herring" that needs comment: This is the amount of pollution produced by the power plants that make the electricity used to charge the electric cars at night. Of course, the best way to

address this is to use solar or wind powered power plants and cut the pollution to zero. However, even if coal-fired plants are used, their high thermodynamic efficiency and the careful pollution control measures now required cut the air pollution per mile driven to a tiny *fraction* of that presently released by even new, well-tuned, gasoline-fueled cars.

Maybe the *Science* article has done us a service by bringing to light an environmental problem that needs to be addressed now, even before we switch over to "non-polluting" electric cars.

[Editor's note: As reported in HP#48 ("A Visit to a Lead Recycling Factory, page 64-66), the study behind the article in *Science* magazine is "flawed by old information, bad math, and poor assumptions," a conclusion shared by the California Air Resources Board, Union of Concerned Scientists, and other transportation agencies and institutes who sent letters to both *Science* and the study's authors. Major funding came from the

Engineering Design Research Center at Carnegie Mellon University, whose industry affiliates include BP America, Exxon Research and Engineering, Mobil R&D, and Shell Development. Other funding for this study comes from the Ford Motor Company.]

#### Access:

Richard Komp, Main Solar Energy Association and SunWatt, RR1, Box 7751, Jonesport, ME 04649. Phone 207-497-2204

*"Carnegie Mellon University has received money from petroleum and auto interests to support a consortium that funded the controversial study regarding the potential environmental effects of lead-acid batteries."*

Science:  
Journal of the American  
Association for the  
Advancement of  
Science.



## Batteries

vehicle assembly plant. But these hazards are small compared to the risks of benzene vapors associated with gasoline.

Thanks to the recent anti-lead acid battery campaign, spearheaded by a Carnegie-Mellon University study,



*“(Lead is ...) the world’s most recycled, non-precious metal.”*

Steve McCrea

Long banks of batteries are charged and tested.

lead-based batteries are newsworthy. Previously, I've attempted to have these photos printed in Garbage magazine and other environmental publications. In 1991 and 1992, no editor appeared to see any value in showing their readers information on the world's most recycled, non-precious metal. Only gold, silver, and other high-value elements have a better rate of recovery than that of lead. According to the Battery Council, most of the “unrecovered” lead in the smelting and re-manufacturing process is trapped in wastes that are carefully stored in company land fills.

Most users of EVs will never see the insides of a battery, just as most car owners will never inspect a gasoline tank or a fuel injector. A curious six-year old who reads GoPower will get a peek at the inside of a battery. Perhaps this next generation's curiosity will nurture a love affair, like my own, with this cleaner form of transportation available today.

### Access

Steve McCrea, 2314 Desota Dr., Fort Lauderdale, FL 33301-1567. Phone 305-463-0158, Fax 462-4423.



<b>Why Gamble on</b> ✓ Un-heard-of brands ✓ AbUSED modules ✓ “Economy” lightweights When you can own the SIEMENS M-55?		<b>DEALER COST</b> PLUS 10% on Trace Inverters (full sized) Sun Frost Refrigerators	
<b>\$289</b> and le\$\$	<b>ABRAHAM</b> Solar Equipment 124 Creekside Place Pagosa Springs, CO 81147 <b>1-800-222-7242</b> THE POWER BROKERS!™	ANANDA POWER CENTERS	NEW, OVERSTOCK
LIMITED TIME	Trace DR1524 inverter/charger <del>\$850</del> \$679 APT Powercenter 5-202-24, LOADED <del>\$2276</del> \$1499 Todd 75 amp charger new style <del>\$324</del> \$209 Washer conversion kit, Whirlpool 24V <del>\$495</del> \$239 Major Project? Ask about on-site service!		

2961 Industrial Rd., Suite 603 • Las Vegas, NV 89109  
 Environmental Marketing, Inc.

**800-732-9880**

*...Our low prices have turned the PV industry upside down!*

# CHEAP POWER

## Inverters 1-800-245-1827

- 12V to 115v Inverter - 140w-200w peak @ \$49.50
- 12V to 115v Inverter - 300w-500w peak @ \$88.50
- 12V to 115v Inverter - 600w-1000w peak @ \$195.00
- 12V to 115v Inverter - 1500w-3000w peak @ \$440.00
- 115v Emergency Switchover Unit at 10 amps @ \$44.50
- 115v Emergency Switchover Unit at 20 amps @ \$56.00
- 12-24V Battery Isolator - 75 amps @ \$32.50
- 12-24V Battery Isolator - 125 amps @ \$44.50
- 12V Pumps 450 gph @ \$16.50 to 2500 gph @ \$72.00
- Computers Assembled to your spec. & Parts

**A.C.I. PO Box 10463, Santa Ana, CA 92711**

# ELECTRIC VEHICLE

COMPONENTS, CONVERSION KITS, PUBLICATIONS, VIDEOS, AND ENGINEERING DESIGN SERVICES FOR THE EV HOBBYIST AND MANUFACTURER...All components selected with safety and reliability foremost in mind....We stock and sell the largest variety of the very best:

- ◆ ADVANCED DC Motors in 8 variations from 3.8 HP to 28.5 HP
- ◆ CURTIS-PMC Controllers, Throttle Potboxes, Footpedals
- ◆ ALBRIGHT ENG. Main & Reverse Contactors in 5 models
- ◆ GENERAL ELECTRIC & HEINEMANN Circuit Breakers
- ◆ BUSSMAN & RELIANCE Safety Fuses
- ◆ SEVCON DC-DC Converters from 56 to 128 V input
- ◆ K & W ENG. Onboard Battery Chargers from 48 to 216 V
- ◆ Full line of CURTIS, WESTBERG, & KTA Meters & Gauges
- ◆ DELTEC Meter Shunts from 50 to 1000 A
- ◆ EVCC Adapter Plates, Couplings, Clamps, & Brackets
- ◆ PRESTOFLEX Welding Cable, MAGNA Lugs, Assy. Tools
- ◆ 5 CONVERSION KITS certified for Calif. \$1000 tax credit
- ◆ Complete ELECTRATHON Drive & Instrumentation Pkg.
- ◆ All New K & W ENG. Tachometer Drive & Amp-hour Meter.

COMPONENTS & PUBLICATIONS CATALOG.....\$5.00  
INFORMATION PACKET.....SEND S.A.S.E.

## KTA SERVICES INC.

Electric Vehicle components and systems since 1984  
944 West 21st Street — Upland, CA 91784  
Tel: (909) 949-7914 — FAX: (909) 949-7916

# FOWLER SOLAR ELECTRIC

226 Huntington Road PO Box 435  
Worthington, MA 01098  
413-238-5974

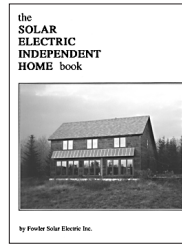

**\$16.95 plus \$2 UPS**  
(includes our \$3 catalog)

This is the most popular book for PV remote homes. It is written and published by Fowler Solar Electric Inc.

“Best all around book on wiring your PV system.”

1991 Real Goods Sourcebook

“Our favorite book for Do-It-Yourselfers.”

Windy Dankoff, Flowlight Solar Power

“This should become the bible for alternative energy users.”

Ken Cox, President Trace Inverters

### Send \$3 for our 64 page catalog and product guide

We have West Coast mail order pricing with the reliability and courtesy of a family owned New England business. Since 1981. We live with and use the products we sell and design.

*Best book, most user friendly catalog, and best kits in the business.*

Servel/Dometic Gas Refrigerators. Trace Inverters. Trojan Batteries. Siemens, Kyocera, and Solarex PV modules. Osram Bulbs. Thinlite Fixtures. Aquastar Hot Water Heaters.

# Introducing the SYSTEM 2000 from STABER INDUSTRIES, INC.



- Made in the USA
- Top-loading convenience
- Horizontal axis tumble performance
- Patented design
- No transmission
- Electronic drive universal motor

Compared to typical agitator washers, the System 2000...

- Washes up to 50% more clothes
- Uses 66% less water
- Requires up to 50% less energy
- Cuts hot water usage
- Spins faster to help cut drying time
- Excellent payback period

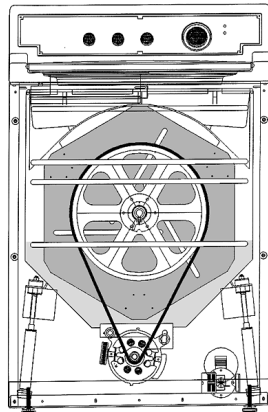

To learn more about the System 2000 or to request dealer information please write or call:

**1-800-848-6200**

**or 614-836-5995**



**STABER INDUSTRIES, INC.**

4411 Marketing Place Groveport, Ohio 43125

# Solar Pathfinder

Find the absolute best location for your PV panels with the Solar Pathfinder, the only instrument available that provides a full year of accurate solar data in a single reflected image. Provides an easy-to-understand “solar blueprint” of your site, as well as a permanent record for you or your client.

**SAVE 10%** on a Pathfinder with the metal case and tripod! How? Take advantage of our scratch and dent sale! We have several metal cases that have small dents and scratches or the paint isn't quite right, and we need to get rid of them! So order now and tell us that you want a Pathfinder with a dented case. Our supply of scratched or dented cases is limited, so don't wait!

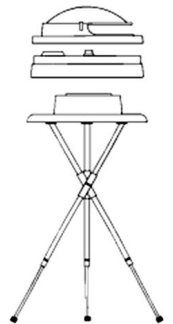

## Solar Pathfinder

25720 465th Avenue, Dept HP  
Hartford, SD 57033-6328  
Phone & FAX: 605-528-6473  
Internet e-mail: solarpf@aol.com



Things that Work!  
tested by Home Power

Pathfinder with metal case, tripod, sunpath diagrams, and manual \$216. Hand-held model without case or tripod, \$139 Diagrams \$10.50. New manual \$18. All prices post-paid.



VISA or Mastercard accepted.



# Things that Work!



Things that Work!  
tested by *Home Power*

## Hughes/RCA Digital Satellite System

tested by John Wiles

©1995 John Wiles

If you live away from the big cities and small towns, have poor to non-existent TV reception, and enjoy video entertainment, then the new Hughes/RCA Digital Satellite System (DSS) might be just what you are looking for.

This satellite-direct-to-home TV system got started in 1994 with the launch of the first high-power satellite stationed in geo-synchronous orbit over the equator south of Texas. The high-power transmitters (120 watts) allow signals to be received at most homes in the continental US with just an 18-inch mini satellite dish. A second satellite joined the first and a third is to be launched in the Summer of 1995. More than one million of these units have been installed and Sony and others will be producing DSS under license from Hughes and RCA starting this year.

The system is entirely digital and with digital recorders at the program origination points, the video quality is equal to or better than laser disks. Audio quality is equal to CDs. The quality that the viewer/listener gets in the home is dependent on the quality of the home TV or audio/video system. After the digital signals have been converted back to the analog form, the DSS has three types of output for connection to the TV set. The system puts out a radio frequency (RF) signal and monophonic audio on channel 3 or 4 for connection to the antenna input of any TV. The video quality is at least as good as that TV could produce if it were in the same town as a TV station. Audio quality is limited by the speakers that are in the set. The DSS also has stereo audio and video outputs for connection to a TV or external audio system that has those inputs. The quality of these signals is extremely good, equaling or

bettering the best signals that can be obtained from a cable TV system with CD quality sound. As before, the internal speakers of the TV and the quality of the TV determine the performance. The best video from the system (400 lines of horizontal resolution) comes from S-VHS outputs that can be connected to TVs or video monitors with those inputs.

A 25+ hour program guide is transmitted for all channels and numerous menu-driven, viewer options allow the program guide and the received channels to be custom tailored for selection and viewing. The basic system comes with a remote that controls the DSS receiver and the TV (if equipped with a remote control).

### Performance

The performance of this system is nearly ideal. There are no faint ghosts, white flecks of noise, or poor sound quality. The images are sharp and clear with full color saturation. Video monitors can have the sharpness controls turned to near maximum. Newscasters with five o'clock shadow or split ends are all shown with great clarity. The video is far better than that produced by the typical VHS VCR.

The original MPEG-1 (Motion Picture Experts Group) digital encoders allowed a glitch or two at infrequent intervals (one frozen or mosaic frame per hour) on live sports and some fast action scenes, but the new MPEG-2 digital encoders and compressors are minimizing most of those troubles. In some locations, very heavy thunder storms and heavy rains may cause the signal to fade for a few minutes until the dense, signal-absorbing storm passes. The system transmits in the 12.2-12.7 GHz range, so heavy rain and other atmospheric disturbances may disrupt the system. DSS is a digital system so there is no noise or poor reception. The signal is either there with the satellite receiver locked on with full fidelity or not there at all. In the dry Southwest with locally heavy thunder storms, 30 days of casual TV viewing have witnessed no loss of picture. The system is designed to provide an excellent picture 99.7% of the time.

A clear view of the southern sky with no trees or power lines is required, but the beam is very narrow from the dish to the satellite. The actual pointing angles (where the clear view is needed) depend on the location of the dish installation in the US with respect to the satellite. The installation instructions and built-in software make the aiming a snap. Professional installation is also available from the dealers, but do-it-yourself installation should pose no problem for the home handy person. A well-written, 72-page Installer Guide provides detailed instructions for all most any situation.

A 60-page User's Manual does an excellent job of explaining the basic features of the system. The User's Manual does point out that the owner should "play" with the system to learn the full capabilities. The on-screen program guide is only the start of numerous menus and help functions that are accessible with the remote control. The Customer Service Staffs at both DIRECTV and RCA are only a toll-free call away 24-hours per day. They generally provide excellent assistance and can transfer the caller to the Technical Staff when the questions get too tough.

Dealers and some Customer Service personnel will state that the connection to a telephone line must be made to have the system work properly or at all. This is not true. The telephone connection is used once per month to give the central computer(s) the billing information for all Pay-Per-View (PPV) movies that were watched. The viewer can impulsively select PPV movies and these Impulse Pay-Per-View (IPPV) charges are recorded in non-volatile memory in the receiver on a special access card that stores the information. The access card also stores the decryption codes for receiving the various packages that have been bought. On a particular day of the month, the receiver calls a toll-free number through the phone and relays the charges to the central billing computer. If IPPV is used, then the power must be on the receiver and it must be connected to the phone for 24 hours on the call-back day. No telephone? No problem. Notify the program supplier and they will inhibit the IPPV function and the user must call a toll-free number to get PPV programs. Each request call is subject to a \$2.00 service charge, but as many movies as desired can be scheduled on one call.

**Power**

The DSS receiver is labeled at 34 watts but measurements made with a digital wattmeter/ammeter/voltmeter indicate that it draws about 25 watts (0.4 amps at 120 volts) when "on" and 25 watts (0.4 amps at 120 volts) when "off". The internal digital processing equipment stays on continually so that the program providers can send electronic messages to the mail box. A typical message might inform the user that a new channel is available. Contrary to what dealers will say, the power can be removed from the system. All of the user-selected parameters (too numerous to list) and any billing information are retained in non-volatile memory on the access card. Whenever power is again applied to the system, these parameters are ready for use.

The DSS receiver uses transformers, rectifiers, and linear power supplies so its use on PV systems with pulse-width modulated (PWM) inverters should present

no problems. The power supply is internal to the receiver (no power cube on the wall) and the unit must be in a ventilated area. DC operation or conversion does not appear practical. As with other audio equipment, high battery voltages and the resulting high ac voltage peaks on PWM inverters may cause problems. Of course, if the system should self destruct the first time it is turned on, there is a warranty, and Exeltech makes a 250-watt sinewave inverter that will power it nicely. The DSS works well on the output of a Trace 4024 sinewave inverter.

**Costs-Hardware**

The basic DSS antenna and receiver cost \$700.00. About \$50-75 worth of cables and miscellaneous parts are needed to complete the installation. Kits of installation parts and various accessories make one-stop shopping a reality. These items are available from DSS dealers (many in most large towns and cities). Since the system has only one signal output (in differing formats), all connected TVs must view the same channel. For \$900.00, a deluxe system is available which has two outputs from the dish, double gold-plated audio/video output jacks, and a remote that will control four separate devices. A second cable is then used to connect a second receiver (\$650.00) to the dish which allows two separate programs to be watched.

**Costs-Software**

All of the signals from the satellite are digitally encrypted and none are free. They are marketed by two different companies (DIRECTV and USSB) which sell packages of programs. Some Co-op telephone companies are also offering program packages. With two satellites there are 175 channels available including numerous PPV and sports channels, 28 music (audio-only) channels, network feeds from selected super stations, and a very large assortment of the typical cable TV channels. The third satellite will add even more channels.

A selection of about 30 channels with 28 music channels and the five network channels from DIRECTV costs about \$35.00 per month. The first PPV movie each month is only 49 cents because DIRECTV sends out a \$2.50 credit each month. Numerous premium movie channels, sports channels, and the Pay-Per-View movies are available at additional cost. Most programs are transmitted in stereo sound (except the old movies) and many of the newer programs have closed captions. Alternate languages are available on some of the movie channels.

The DSS is entirely separate from the PrimeStar system which is owned by the cable TV companies.

## Things that Work!

PrimeStar rents equipment and provides a lesser number of program options. PrimeStar is not currently a digital system and uses a dish that is larger than the DSS mini-dish.

### Summary

The initial cost of the system is not insignificant. The monthly programming charges are typical of cable TV fees and when premium channels are added, they are very competitive with cable. Some of the channels have no commercials. The audio and video quality are unequalled. When the costs of driving into town to rent videos are added to the rental costs and VCR maintenance costs, Home Power Magazine readers might want to consider putting a Digital Satellite System on their entertainment budget.

### Access

Author: John Wiles, SWTDI/NMSU, Box 30,001/Dept 3 SOLAR, Las Cruces, NM 88003 • 505-646-6105

DSS Hardware Information, RCA/Thompson: 1-800-679-4776

DIRECTV Programming: 1-800-347-3288

USSB Programming: 1-800-204-USSB



## AUTOMAGIC BATTERY WATERING



### WE MAKE WATER FROM YOUR GAS

Hydrogen and oxygen battery gas catalytically recombined into pure water and returned to each battery cell. Keeps battery topped off for extended periods of time and reduces maintenance costs. Explosive hydrogen gas is virtually eliminated from the battery area. Corrosive spray and fumes are contained and washed back into each battery cell. Electrolyte kept strong longer, extending the useful power and life of the battery. HYDROCAP Vents simply replace the battery's caps. Battery maintenance is greatly reduced. Write or call for more information.



Things that Work!

**Hydrocap**  
CATALYST BATTERY CAPS®

305-696-2504  
975 NW 95 St.  
Miami, FL 33150

# Need a Job?

Get a good-paying job instead of a Dead End minimum wage slave job. Sell solar power generators on location. You buy from us or take orders; we ship to you or buyer.

You are only limited by your time and efforts. This worthwhile job enables you to help the environment and earn as much money as you want. Distributorships are available for qualified individuals. We do not discriminate. We reward those who produce the most business for the company. Nationwide and international opportunities available.

**Call (805) 563-2687**

**Solar Systems LTD**

32 W. Anapamu St. #257, Santa Barbara, CA 93101

**ENVIROtech**

## Radiant Fireplaces

Warm your home, bake your food and heat your domestic hot water with a clean burning EnviroTech Radiant Fireplace kit. Build your own masonry heater using easy to install modular pieces. Provide even, comfortable radiant heat to your home with one to two fires a day. Use wood, the renewable resource. Clean-burning—0.99 g/hr

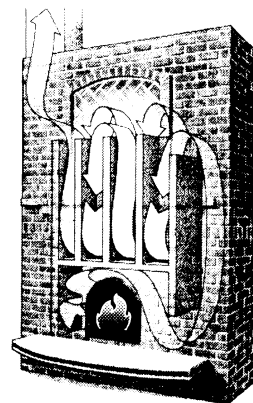

EPA Accepted

For Information call or write

**Dietmeyer,  
Ward & Stroud, Inc.**

P.O. Box 323  
Vashon Island, WA 98070

1-800-325-3629

## GO SOLAR

*"Alternative Energy Products For Independent Living"*

Serving the New York, New Jersey, Connecticut  
and Long Island Areas

We Specialize in Combined Solar-Electric and  
Solar-Thermal Energy Applications & Designs.

**Call — 1-(516) 727-2224**

Our "Fully Equipped Off The Grid"

Office & Showroom is located at:

1446 Flanders Rd., Riverhead, New York 11901

**PHOTOCOMM, INC.**  
AUTHORIZED DEALER

**TEAM SOLAVOLT**

ADVANCED COMPOSTING SYSTEMS

camera ready

b/w

7.1 wide

2.25 high



**ENERGY OUTFITTERS**

Power Systems & Appliances For Off Grid Living

Now In Stock & Ready To Ship:

**STABER INDUSTRIES**

**System 2000**

**Washing Machines**

136 S. Redwood Hwy. POB 1888  
Cave Junction, OR 97523  
1-800-GO-SOLAR (800-467-6527)  
(Dealer Inquiries Welcome)



World's **MOST COMPLETE** SourceBook™ of Energy Efficient and Renewable Energy Products!

Our SourceBook™ includes information and pricing on Building Environments, Daylighting, Solar hot water, Solar electric (including alkaline batteries), Wind Generators, Hydrogen, Hydroelectric, and Bio-Fuels. The regular price is \$8.95, but Home Power® readers only pay \$3.00 to cover shipping and handling! If you have seen the rest, then get the best!



**UtilityFree™, Inc.**

74 Sunset Dr., Suite D  
Basalt, CO 81621

1-800-766-5550 Orders  
(303) 927-1331



Internet E-mail: [utilfree@infosphere.com](mailto:utilfree@infosphere.com)  
\* Dealers send for application. (303) 927-1325 FAX 24 hours

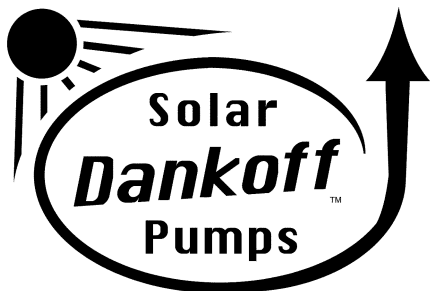

**Water Supply Solutions**

**DC & AC Pumps in All Voltages**

**High Efficiency • Low Power Surge**

- Domestic
- Irrigation
- Livestock
- Lift & Pressurizing

- Flowlight® Booster Pump*
- Solar Slowpump™\**
- Solar Force™ Piston Pump*
- SHURflo® Solar Submersible*
- Solar Centrifugal™ ... & more*



\*Things that Work!  
tested by Home Power

For design assistance or dealer support —————→ **Ph/FAX (505) 820-6611**  
**Dankoff Solar Products, Inc. 100 Ricardo Rd. • Santa Fe, NM 87501**

# Great Plains POWER

*Autumn Ad Special  
'Solavolt'  
photovoltaic panels*  
72 watt \$390.00 each  
80 watt \$425.00 each  
85 watt \$460.00 each  
*inquire for other  
savings*

*Photovoltaic Energy Systems*

Patrick Osborne (303)239-9963 fax (303)233-0410  
1221 Welch Street • Golden, Colorado • 80401



## SKYLIGHTS

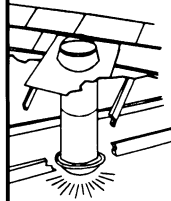

### New Tubular Design

Bring natural sunlight to any room or area.

- \* Low cost
- \* Easy to install
- \* Fits all roof styles
- \* Cuts power bills
- \* Ideal for mobile homes
- \* Weatherproof
- \* New low profile
- \* UV Protected
- \* Made in USA
- \* Lifetime warranty

"Time to Lighten Up"

Call or write today for full information.

**Solar Bright**  
*Tubular Skylights*

**Solar Bright Corp.**  
3665 E. Bay Dr. Suite 204-256  
Largo, Florida 34641

**1-800-780-1759**

## WORLD POWER TECHNOLOGIES

camera ready  
black and white  
4.7 wide  
2.35 high

## SIMMONS PURE SOAPS



For FREE Catalog of Hard to Find Natural  
Bath & Bodycare products made in an  
alternative energy environment, send to:

**SIMMONS HANDCRAFTS**  
42295-AE Hwy 36, Bridgeville, CA 95526

## NORTHWEST ENERGY STORAGE

camera ready  
black and white  
7.0 wide  
4.6 high





# Home Power's Business

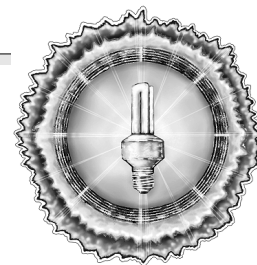

"The man who on his trade relies  
Must either bust or advertise."

Sir Thomas Lipton — 1870

## Display Advertising

### Advertising Rates per Consecutive Insertion

	Single Insertion	Three Insertions	Six Insertions	Ad Area sq. in.
Full Page	\$1,200	\$1,080	\$1,020	64.13
Half Page	\$672	\$605	\$571	32.06
Third Page	\$480	\$432	\$408	21.38
Quarter Page	\$377	\$339	\$320	16.03
Sixth Page	\$267	\$240	\$227	10.69
Eighth Page	\$214	\$193	\$182	8.02
Twelfth Page	\$150	\$135	\$128	5.34

Four process color (CMYK) in any sized advertisement for a flat rate \$185 per insertion. For inserts, and current subscriber/circulation demographics, please call us.

Home Power is published bi-monthly. Ad deadline for the Dec 95 / Jan 96 issue (HP #50) is 20 October 1995. Call or FAX 916-475-3179 for further details.

## International Subscriptions

Due to the high cost of international mailing, we charge more for Home Power international subscriptions.

### 1 YEAR — 6 ISSUE INTERNATIONAL RATES:

#### All payments in U.S. currency ONLY!

Canada:	Air — \$36	Surface — \$30
Mexico:	Air — \$38	Surface — \$30
Western Hemisphere:	Air — \$40	Surface — \$30
Europe:	Air — \$53	Surface — \$30
Asia and Africa:	Air — \$64	Surface — \$30
Pacific Rim:	Air — \$64	Surface — \$30

Surface shipment may take up to three months to get to you. All international issues shipped in mailing envelopes. International subs are best paid for by either VISA, MasterCard or funds from a U.S. bank.

International orders call: 916-475-0830  
or FAX 916-475-0941

## MicroAds

MicroAd rates are 10¢ per character. Characters are letters, numbers, spaces, and punctuation marks. \$15 minimum per MicroAd insertion. Send check with your ad. We do not bill MicroAds.

## Home Power Magazine for Resale

Quantities of Home Power Magazine are available for resale by distributors, newsstands, bookstores, energy businesses, and others. Please call or write for rates and shipment specifics.

## Back Issues of Home Power Magazine

Back issues through #20 are \$3.50 each (\$4.25 each outside USA) while they last. Sorry, no more issues #1 – #10 or #15, or #36. Back issues of #21 through #45 are \$4.75 each (\$6 each outside USA). Back issues #46 to the present issue are \$5.75 each (\$7.25 outside USA). All back issues are shipped first class mail in an envelope or box. See this issue's ad index for our current Home Power Back Issue specials. The text and line art from back issues #1-#35 on CD ROM (IBM & MAC) is \$29 each.

## First Class Home Power Subscription

Home Power Magazine (6 issues) via First Class U.S. Domestic Mail for \$36. Many of you have asked for faster delivery of your issues. So here it is: First Class Home Power. All First Class issues shipped in an envelope. We start your subscription immediately with the current issue.

## Second Class Home Power Subscription

Home Power (6 issues) via Second Class U.S. Domestic Mail for \$22.50. Second Class is forwardable for one issue (2 months), so let us know immediately if you move! We start your sub with the next scheduled issue, so please allow ten weeks for your first copy to arrive.

**ACCESS** ➡ **Home Power, PO Box 520, Ashland, OR 97520 USA**  
**800-707-6585 or 916-475-0830 Subscriptions and Back Issues**  
**916-475-3179 Advertising and Editorial**



# Independent Power Providers

Don Loweburg & Bob-O Schultze

©1995 Don Loweburg & Bob-O Schultze

California, for better or worse, is emerging as a leader in PV/Utility and utility deregulation schemes. Utilities and utility regulators across the country are watching and waiting to see where it goes. The utilities, for the most part, are NOT the leaders in implementing new technologies such as residential scale rooftop PV, wind, and microhydro generators. They certainly don't develop new strategies to encourage anyone to generate their own power rather than buy it from them, even if that generation has positive long term effects for the utility, the customer, and the planet.

Unless direct access to the end consumer is achieved, the push must come from energy regulators and legislators mandating positive change. They, in turn, must be pushed or dragged along by energy consumers demanding access to clean, renewably produced power.

## Net metering on

Net metering is available now in California. Governor Wilson signed the legislation into law in August. Though net metering does not make PV instantly cost effective, it does provide an important context for the future of customer owned rooftop PV. The success of this project was due to the hard work of CALSEIA, especially staffer Cathy Murnigan, Tom Starrs who crafted the legislation, wide industry support, the many letters from IPP and the support of Southern California Edison. Results like this can come about when everyone works together on a common goal. Hopefully PV4U collaborative in other states can go to work on issues like this that will help commercialize PV. How about some juice from SEIA on the national level?

There is a great deal of constructive work that can be done within the collaborative process that can

accelerate the commercialization of PV. Some of the areas, in addition to net metering, that have been discussed are: technical standards for equipment, financing, promoting end-user and third party ownership of PV and developing a strong and capable service infrastructure. If you have an interest in user owned PV and a strong service infrastructure, you must get involved. Become a member of IPP. Seek out your state energy commissions and other agencies hosting the state collaborative on PV commercialization. Seek alliances with environmental and consumer groups. Too political? Too much time needed? Too bad! If you don't get involved, the other players in this process will determine your future options.

## REDI Conference '95

On August 11th, Don & Cynthia and Bob-O & Kathleen traveled to Willits, CA for the Renewable Energy Development Institute 1995 conference. This is a biannual event which coincides with the big Solar Energy Expo & Rally (SEER) every other year. During the REDI only years, such as this one, the focus is on ways and means to promote Renewables. REDI '95 had two main themes: Energy and Transportation. Both conferences ran concurrently so you had to attend one or the other. Don and Bob-O focused on the energy conference and the topics of financing, the ongoing Southern California Edison off-grid and upcoming SCE on-grid pilot projects, and the effects of utility restructuring on renewable energy and energy conservation industries. Michael Hackleman covered the transportation conference for *Home Power*. Look for his report on doin's in HP#50.

## Financing

Maureen Senn from the North American Mortgage Co. led off this discussion with a presentation of what her company is looking for to consider lending on an off-grid home. Given creditworthiness of the borrower, her company is willing to stretch the definitions of location, timeframe, and number of turnovers in determining comparable sales or "comps" in the off-grid market. This has very little to do with the encouragement of RE homes (a generator is almost always required by the lender for "backup"), but it is an acknowledgement that RE homes do exist in numbers and quality which are worth the lenders time and effort to pursue. She stressed that the most important aspect of financing is the appraiser's report and most appraisers don't know or understand about RE.

IPPs have faced this problem from the start. One of our long term goals as an organization is to develop or help develop an RE accreditation program for appraisers. Once appraisers understand what RE systems add to a

home in today's marketplace and are comfortable in assessing that real value, the lenders will follow.

Michael Martin of CHEERS (California Home Energy Efficiency Rating System) presented his organization's system for rating the energy efficiency factor of a house. Simply put, if your home uses less energy, you will have to spend less to provide it. This translates into a better income/expenses ratio which means you could either make payments on a larger mortgage or more easily afford a smaller one. While CHEERS does not have a rating system for RE homes per se, RE powered homes are nearly always built with at least electricity efficiency in mind, which gets points under the CHEERS system.

The last financing presenter was Keith Rutledge of the Bank of Willits. Keith is a long time advocate of commercial bank financing for off-grid homes. His bank is a portfolio lender (they keep the loan rather than sell it to the secondary loan market) which has lent money on many RE powered homes. While a portfolio lender has more latitude in financing "non-conforming" homes, the basic rules of marketability (in case of default) still apply. Keith is a strong advocate of compiling a national databank of loans on off-grid homes to provide low cost access to information on comparable properties for appraisers, lenders, and individuals alike. IPP strongly supports his efforts.

#### **SCE's Off-Grid Pilot Project**

Wayne Gould, SCE's Manager in charge of PV projects, presented a progress report on their pilot off-grid program. Despite a colorful slide show and his best efforts to put a utility spin on the report, the data was not promising. In the past year, one project was completed and three are pending. Revenues = \$3,000. Outlays = \$271,000. That puts the cost of the program so far at \$268K. Yikes! To his credit, Mr Gould admitted SCE made a big mistake by going into the program with an attitude of completely ignoring the IPPs and their expertise. They've learned far more than they thought they knew. Still, without some serious restructuring AND the support of IPP the project seems doomed.

Don Loweberg presented the IPP view of the program. IPP has maintained from the beginning that SCE's off-grid PV program was a bad idea and it is no surprise that it is failing. We believe they also discounted the IPP willingness to fight for the industry which IPPs created. Don presented the view that the most cost-effective way to implement PV off-grid is for Edison to simply hand a list of Providers to someone asking for an uneconomical line extension. If the customer wishes to take advantage of Edison's financing opportunity,



Above: Don Loweberg addresses REDI '95 in Willits, California. Photo by Bob-O Schultze

they and the Provider can design a cost-effective system and take it to Edison for financing approval.

#### **Effects of Utility Restructuring/Deregulation on Renewables**

These subjects were the keynotes of the conference. They will be the subject of conferences for years to come. Just as it happened to the telecommunications industry, utility restructuring/deregulation is going to happen. The questions are only when and how. The basic tenet of restructuring is to separate the three main components of power providing into generation, transmission, and distribution. Once these three factors are "unbundled" and billed to the end-user as separate items, he or she may eventually be able to choose which company generates their power. Transmission costs will be determined by where the provider is located and distribution will, at least for now, be provided by your local utility which owns the wires to your home. According to Jay Morse of the CA PUC, billing for these services may even be taken over by independent accounting firms. This is called direct access or retail wheeling. While direct access may well benefit the RE industry by giving individuals their choice of providers and competition will force the power industry to get lean and mean, it's no free lunch. For example, with less or no cross subsidization of costs in different classes of power users, remote customers may pay more for power than city dwellers due to increased line extension and maintenance

costs. Real time, "Time of Day" pricing will become the standard as prices closely follow costs. Many pundits, Amory Lovins among them, claim that direct access is an illusion and politicians will never let it happen. Never is a long time. If/when it does, the effects on small scale renewable producers could be immense.

On Saturday evening Amory Lovins made a presentation via live teleconference, sharing some of his views about utility restructuring and renewables. He is the originator of the term negawatts and has been a leader in presenting the importance of energy efficiency in economic terms. He stated that restructuring will favor the few largest purchasers of power to the disadvantage of the smaller consumers. Further more, he asserted that Demand Side Management programs are being slashed in spite of their cost effectiveness. Then he shifted direction, stating that competition, wholesale or retail, really was a moot question.

The rapid advances in decentralized generation, photovoltaics and fuel cells, coupled with their "distributed benefits" will make centralized generation less competitive. Coupling distributed benefits with energy efficiency makes this approach five to ten times more valuable than just evaluating bulk power (KWH). As Amory said, "The more rigorous our engineering economics, the faster the power plants, and new storage devices like superflywheels, will shift to our roofs, basements, and backyards. This "withering away of the utility" will then make utilities write-off remaining central power plants—magnificent engineering achievements but no longer competitive. And so Thomas Edison's vision, including his sale of energy services (light and torque, not KW/H), will at last be fulfilled."

Later that evening an informal PV4U meeting was chaired by Mike DeAngelis. We reviewed what had happened since the last REDI conference two years ago. I think most would agree that an amicable atmosphere prevailed. There was some discussion about what the future role of the collaborative should be. The next full PV4U meeting will be held in San Diego, the 14th of September. Future projects for the collaborative will be discussed

Sunday morning the results of the "PV shoot-out" were presented. The shoot-out consisted of a side by side test of several PV modules set up in the REDI parking lot. The test logged the total ampere-hours output over a two day period. The results of the test provided a focus for discussion about the way modules are tested and the significance of the results. My conclusion from these conversations is that module rating is slippery

indeed. Some things I think all would agree on. 1.) The simple parameters; volts, amps, and watts are insufficient measurements when meaningful comparisons between modules are desired. 2.) Most manufacturers try to present their product in the best light, emphasizing the strong points; low light performance, dollars/watt, most ampere hours, good partial shade performance, hot weather output, and so forth while declining to present data on weaker performance items. 3.) A single I-V curve generated by flash testing a module in laboratory conditions at 25°C cannot be used to fully describe the actual performance of a PV module in the real world.

So how can a module be evaluated? Work is going on to define a more meaningful rating system that recognizes some of the real world variables present in using PV modules for different tasks. Some criteria that might be defined are; What are the environmental conditions, high or low temperature, low intensity or high intensity illumination, tracked or stationary mount? What is the application, power point tracking or battery charging? NREL is working on this project and will soon have a report out.

### **Disinformation, let's tell it like it is!**

"Lunch box electricians", "Mom and pop operation", "Cottage industry", "Under capitalized", "Unprofessional", "Schlocko electrician", Sound familiar? These are all terms I've heard attributed to the PV service industry in the last two years. In each case I just sort of let it in. I know that we are a new industry and in some specific cases the comment might have been valid. I am concerned, though, that I perceive a persistent pattern that does not conform to the facts in most cases. If I were to single out a source for these comments, most often it would be the professional cadre of the utilities and DOE. I am coming to regard expressions like these as intentional disinformation. As disinformation it is designed to serve a specific strategy. The strategy, of course, is that the PV service industry is undeveloped and "needs" the expertise and help of the utilities. "Let me help you out", said the spider to the fly.

### **Access**

To Join IPP: By E-mail: [i2p@aol.com](mailto:i2p@aol.com) • By phone: (209) 841-7001 or (916)-475-3402. Write and send tax-deductible donations to: IPP, PO Box 231, North Fork, CA 93643

Authors: Don Loweberg, PO Box 231, North Fork, CA 93643 • [ofln@aol.com](mailto:ofln@aol.com)

Bob-O Schultze, PO Box 203, Hornbrook, CA 96044 • [econnect@snowcrest.net](mailto:econnect@snowcrest.net)



America's premier concentrating PV array brings you more power than ever before —

## Introducing the MLB 3416-115

**USING NEW EFFICIENT BACK CONTACT SILICON SOLAR CELL, MIDWAY HAS CREATED A SOLAR ELECTRIC POWER SOURCE MORE COST EFFECTIVE THAN ANY OTHER**

- Two-stage optical concentration—over **THREE HUNDRED SUNS!**
- Electrically tracks the sun without any adjustment, year in and year out.
- Array automatically repositions to the East after sundown!
- Withstands over 100 mph windloading!
- Uses new Wattsun controller that connects directly to your battery for ultimate reliability.
- Optional internal battery pack controller available



- 2 Module 230 watt
- 4 Module 460 watt
- 8 Module 920 watt
- 12 Module 1380 watt
- Includes the tracker!
- TEN year warranty
- Made in the USA



**MIDWAY LABS, INC., 1818 East 71st Street, Chicago, IL 60649 USA**

**Paul Collard or Bob Hoffmann 312-667- PVME (7863), FAX 312-667-6577**

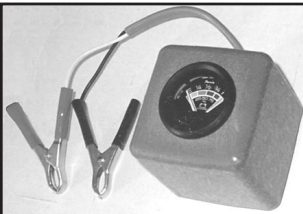

**THE LOW COST Battery Condition Indicator**  
Quickly and accurately shows percent of charge in all 12 Volt batteries. Optional: Cigarette lighter plug for use in vehicles. Single gauges also available, easily wires into your system.



4052 Ridge Road  
Gordonville, PA 17529  
717-656-1644  
Elam S. Beiler  
Satisfaction Guaranteed

**Special Introductory Price**  
includes shipping in continental USA  
**\$28.00.**

Single gauges \$15.00  
Made in USA

Please call or write for free brochures or quantity discounts. (1 year warranty)  
Dealer inquiries welcome



A Wholesale Supply House

**SOLARTROPE**  
**HOT WATER SYSTEMS**

Pool ■ Spa

**SOLAR ELECTRIC SYSTEMS**

RV ■ Marine ■ Remote Home

Parts For All Systems

**Solartrope Supply Corporation**

**800-515-1617**

DC/Propane Refrig, Track Rack

AC/DC Inverters, Charge Controller



**1-800-564-0403**

**HORIZON INDUSTRIES**

**We Sell The Best & Service The Rest**

PHOTOCOMM, INC. AUTHORIZED DEALER **TEAM SOLAVOLT**

Mention This Ad and Receive A Free Catalog  
2120 L W Mission Rd, Escondido, CA 92029  
Mail Order or Fax  
**(619) 480-8322**





Water Pumps, DC Lights, DC Appliances

Batteries, Cables, Switches

**Keep Your Batteries Alive**

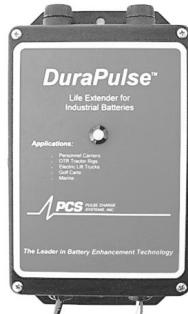

New patented high frequency electronic pulse device is guaranteed to rid your lead batteries of sulfation. Without sulfation, your batteries will operate like new and can last up to 5 times longer. Will rejuvenate sulfated dead batteries. No more high volt equalize charges or worry about your battery state of charge. Use with charger.

DuraPulse—Input: 3.3 watts; 12 VDC range; 2 models, operate above 10.5 V. or 12.6 V. Specify. Output 2, 6, 12, 24, or 36 VDC; Specify

MiniPulse—Input 110 VAC. Output: same as above

Mainline Electric  
4324 Fern Valley Rd.  
Medford, OR 97504  
Dealer Inquiries

Visa/MC/Dis  
800-221-9302  
Fax (503) 535-8833  
Technical ? (503) 535-9862

Will not rejuvenate shorted or worn batteries.

# Code Corner

## The 1996 National Electrical Code and Cable Updates

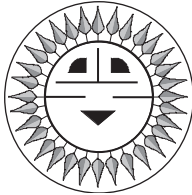

John Wiles

©1995 John Wiles

The final changes to the 1996 National Electrical Code (NEC) have been written, discussed, revised, and balloted. The 1996 NEC is nearing publication and should be available later this year. Adoption of the 1996 NEC by the many state and local governments is automatic, but may take much longer in other jurisdictions. There are some significant changes for 1996 that will effect the installation of PV systems.

Some additional information on the use of cables has come to light and should be of interest to PV installers doing commercial installations.

### 1996 NEC

#### Cable Marking

Section 200-6 (a) Exception No. 5 will now allow the grounded, small (18-4 AWG) conductors used in PV array wiring to be marked at the ends with white tape or paint. Until now, marking of conductors smaller than Number 6 AWG was not allowed, and the PV installer had a problem, because most of the sunlight resistant, single-conductor cable is black. Cable that has the necessary white color and outdoor rating is almost nonexistent.

#### Grounding

Section 250-93 has been revised so that the requirements for the DC grounding electrode conductor are similar to the requirements for the ac grounding electrode conductor. In most cases, where only the grounding electrode conductors are attached to the ground rod, the DC grounding electrode conductor can

be as small as Number 8 AWG copper. The DC grounding electrode conductor is no longer required to be as large as the largest DC conductor in the system. There are still restrictions, so the new code should be reviewed when planning an installation. Yea! No more monster cables to the ground rod!

#### Definitions

Many of the definitions in Section 690-2 have been cleaned up. In particular, the terms "Power Conditioning Unit" (PCU) or "Power Conversion System" (PCS) have been replaced with the more commonly used term "Inverter". Several other definitions (such as "Inverter Input Circuit" ) were added to assist in the use of new sections of the code.

#### Diagrams

Although the grid-tied diagram in Figure 690-1 is still in the 1996 Code, the NEC Handbook for 1996 should have several example diagrams of other types of PV systems.

#### System Voltage

System voltage is now defined in Section 690-7 as the highest open-circuit voltage between any two conductors in the system. In non-residential applications, there is no longer a 600-volt limit on PV system voltages. However, there are stringent Code requirements in Article 710 for the installation of any electrical power system over 600 volts. Furthermore, the hardware required to install systems over 600 volts is expensive and difficult to find. Most PV modules are listed for operation up to 600 volts.

#### Circuit Sizing and Current

Section 690-8 (b) (3) and (4) now define the requirements for determining the input and output currents for the inverters. These calculated currents are to be multiplied by 125% before sizing cables and overcurrent devices to ensure that this hardware is not operated continuously at more than 80% of rating.

#### Flexible Cables

Section 690-31 (c) has been added to explicitly allow the use of flexible, portable cords for moving parts of a tracking PV array. This will allow the SO, SOE, and SOJ cables to be used when they are listed for outdoor use with the "W-A" marking. Ampacity tables are referenced (Section 400-5), and a temperature compensation table is given (Table 690-31).

#### Small-Conductor Cables

If it looks like USE-2, feels like USE-2, and the manufacturer certifies that it is just like USE-2, then Section 690-13(d) now allows small 18-16 AWG cables that are listed for outdoor use to be used for module interconnections. These cables cannot be marked

USE-2 because of the small size. Underwriters Laboratories (UL) will be working with the cable manufacturers to list such cables and mark them with a designation that indicates they can be used in PV systems. These smaller cables will have application to the high-voltage grid-connected systems where the string currents are low.

### Grounding

Section E (690-41-47) was extensively revised and, while not as clear as it could be, makes a lot more sense. It really says that all PV systems need equipment grounds and that all ground rods (ac and DC) should be tied together.

### Marking

Section 690-52 requires that the installer mark the PV system with the system ratings at an accessible location at the PV disconnect.

### Current-Limiting Overcurrent Devices

Section 690-71(c) specifically requires that a current-limiting overcurrent device be used on battery circuits.

### Battery Cables

Section 690-74 allows the use of flexible cables that are listed in Article 400 for connections between a fixed wiring system terminated near the battery and the battery. They are also allowed between the battery cells. This was done to prevent damage to the batteries from too stiff cables, and to eliminate the use of non-listed welding and "battery" cables.

### CABLE UPDATE

In past issues of Code Corner in Home Power, the use of conduit has been presented for containing module wiring. Typically, the diagrams show the use of THHN insulated conductors in conduit between modules and from the array to the disconnect inside the building. The use of THHN in conduit that is exposed to weather or other wet conditions is not allowed by the NEC since THHN cables are not listed for wet locations—only for dry and damp locations. Such dry and damp locations would be inside buildings and in protected areas like crawl spaces.

Section 100 of the NEC gives the definition of dry, damp, and wet locations. All locations exposed to the weather are considered wet. The NEC Handbook explains that if a conduit is mounted in a wet location, then the conductors installed in that conduit must also be rated for wet locations. Apparently, the conduit provides only mechanical protection and not moisture protection. This has been verified in the field when PV junction boxes installed with conduit have been found full of water when opened. Also, most underground conduits are considered to be filled with water unless

specific measures are taken to prevent moisture and moist air from entering. The moisture in humid air condenses when it comes into contact with the cooler sides of the buried conduit.

Cable types that have a 90°C insulation when wet are XHHW-2 (similar to USE-2) and RHW-2. Other cables types such as THHW, THWN, and RHW have a 75°C insulation when wet. Since most modules require the use of 90°C conductors and most module junction boxes operate at temperatures approaching 70°C (the upper temperature limit for 75°C cables), it would appear prudent to use the 90°C XHHW-2 or RHW-2 type conductors when wiring modules with conduit.

In the next Code Corner, the overall list of items that should be considered with respect to balance-of-system design for safety and durability will be discussed.

The author is willing to answer questions on PV design and code issues relating to this and previous Code Corner Columns. Phone, Fax, or write to him at the address below.

### Access

Author: John C. Wiles • Southwest Technology Development Institute • New Mexico State University • Box 30001/ Department 3 SOLAR • Las Cruces, NM 88003 • Phone 505-646-6105 • FAX 505-646-3841

1996 NEC and the 1996 NEC Handbook: The National Fire Protection Association • 1 Batterymarch Park • Quincy, MA 02269-9101 • 800 344-3555



## THE SOLAR BOILER™

### State-of-the-Art Solar Water Heater

- PV powered, drain-back system
- Uses no ac electricity or controls
- Pre-assembled pump/heat exchanger module
- No pressurization/evacuation
- One day installation; no special tools required
- 10-year warranty all major parts



Call today for complete information on our ready to install solar thermal, pool heating, and solar electric home power systems. Dealer inquires welcome.

### Solar Works, Inc.

64 Main Street, Montpelier, VT 05602  
Tel: (802) 223-7804 Fax: (802) 223-8980

# Harris Hydroelectric

## Hydro-Power for Home Use

Works with Heads  
as low as 10 feet.

Prices start as  
low as \$695.

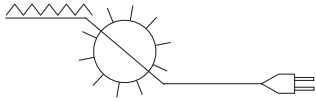

632 Swanton Road  
Davenport, CA 95017  
408-425-7652

"The best Alternator-based MicroHydro generator I've ever seen."  
Bob-O Schultze, Hydroelectric Editor, Home Power Magazine

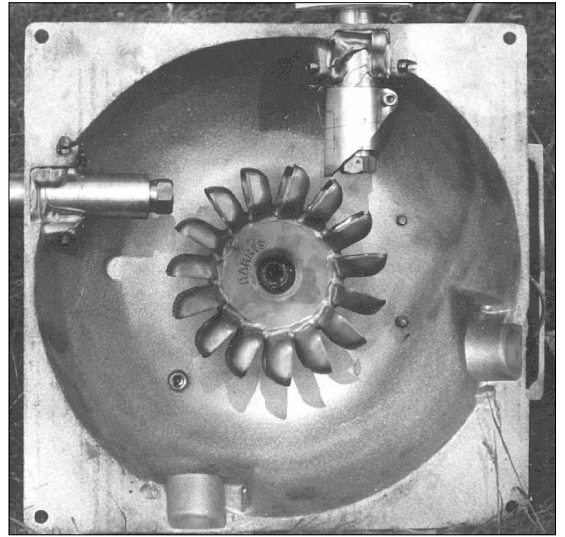

The inexpensive way to  
get hot water from the sun:  
**CheapHeat**  
manifolds

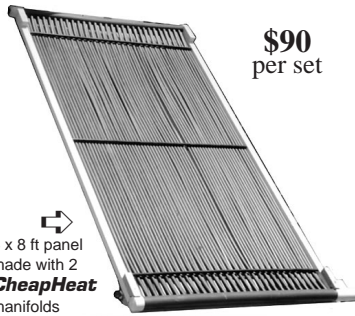

\$90  
per set

4 x 8 ft panel  
made with 2  
**CheapHeat**  
manifolds

A set of two **CheapHeat** manifolds  
enables you to inexpensively and  
easily build your own solar water  
heating panel, four feet wide by any  
length you wish. For full info:

Jeff's Gas Appliances  
549 Central St, Willits, CA 95490  
(707) 459-5223

**\$ WANTED \$**  
DEAD OR ALIVE  
**TRACTOR DEALERS**



**REWARD:**  
**EXCLUSIVE DEALERSHIP**  
**China Farm Machinery**

**CHINESE DIESEL  
ELECTRIC POWER**

**WHEN AND WHERE  
YOU NEED IT!!!**

**Generator Sets  
from \$1995**

CHINA FARM MACHINERY  
Tel. (909) 657-0379  
Fax (909) 657-8120

**NATURLITE**  
2 wide  
4 high  
black and white

## New Products

from Jade Mountain Fall newsletter/catalog

- Residential steam engines
- LED 12V screw base lights
- New PVs at \$4.75 per watt
- Straw Bale building supplies
- Greywater systems & components
- Remote solar medical equipment
- Super energy efficient appliances
- \$89 hand washing machine
- Propane zone space heating
- 112 pages of the best alternative energy products

**Call 800-442-1972**

**PHOTOCOMM, INC.**  
AUTHORIZED DEALER

**TEAM SOLAVOLT**

*Do you want to start business in renewable energy?  
Do you want to find distribution for your products?*

**SOLAR  
ELECTRICITY  
TODAY**

Lists 550+ Current Dealers, Manufacturers, Mail Order Dealers  
and Information Sources. It Costs \$10 in the U.S., \$12 to  
Canada/Mexico. Dealers List on Mailing Labels Available.

**THE PV NETWORK NEWS**  
**2303 Cedros Circle, Santa Fe, NM 87505**



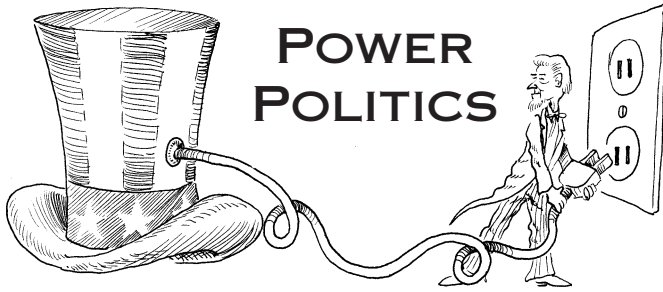

## Rate Based Incentives Update

Michael Welch

©1995 Michael Welch

**R**ate based incentives improve the demand for photovoltaics by paying increased rates to folks with grid-connected, roof-top PV systems (see HP#44 pages 20 & 71, and HP#45 page 72). The money to fund the payout would come from a small utility tax which communities levy on utility customers.

The original concept has taken off very nicely in some European countries. The City of Davis, California may be the first community in the U.S. to put a rate based incentives program on the books. Tim Townsend reports that he has given a proposal to City of Davis which was then referred to the city's Natural Resources Commission for review and possible action. The text of his proposal is available for downloading from the Home Power BBS (707-822-8640).

The Davis proposal has yielded some refinements that are interesting. First, the meter measuring the system's production for payback would measure total PV production, rather than just the energy sold back to the utility. Of course, there would still need to be a meter at the utility connection to determine how much is actually sold back to the utility under CA's newly authorized Net Billing law. At the proposed payback rate of 50 cents per kWh, Tim Townsend estimates that a typical system would be paid for in twelve years. As his proposal points out, it is "far from a windfall investment", but for those of us that want to do the right thing but can't yet afford to, it provides an attractive

incentive. Such a guaranteed income from a PV system may be enough to interest banks in system financing.

Another interesting part of the proposal is the idea of including the local utility (PG&E) in administering the program. The reasoning is that utilities are already in the business of reading meters and writing checks to producers, and it wouldn't be much of a burden to add the incentives program to their system.

I see rate based incentives as an opportunity to create jobs in the community instead of for the utility. The Davis proposal calls for 10% of the monies collected to be used to administer the program. That would likely be above thirty thousand dollars a year. This could fund a great job for someone in the local community under the auspices of a Community Action Agency, the City of Davis or another local energy-related non-profit organization.

### Steps in the Davis Process

There will be a series of three reports to evaluate the program. The first will explore the reasons why they may want to undertake such a program. The report will focus on the benefits ranging from creating local retail jobs in renewable energy to the philosophical choice of using utility taxes to benefit energy-related projects instead of going into a general fund as happens in most communities. It might also discuss keeping Davis in the limelight as the forward thinking community it is known to be. And of course, the main reason: the global advantage of stimulating PV markets so that manufacturers will continue to invest in PV module facilities. This ultimate objective will help bring the cost of PV modules down.

The second report will investigate all the alternatives for the program, and there are a lot of them. It will explore options like who can administer the program, what should be the size limit of the PV systems, and how many systems should there be? A report like this could quickly become very large and take a long time unless care is taken to only look at those things which are reasonable and within the spirit of the proposal.

The third is the planning report to provide the final implementation scenario. The City would base its law and program structure on this report.

Tim mentioned that he hoped that the City Council would be the ones to take action on this proposal, but indicated that there are those involved who would prefer that it be made into a voter referendum. This is a real tough issue to decide. The Council could act more quickly, but what if some members are against the proposal? On the other hand, there is the fear that

voters would see this as nothing more than a utility tax increase, and automatically vote against it.

Current surveys show that not to be the case. For example, a recent poll of the City of Austin, Texas was taken because of that very fear. The pollsters were surprised to discover that an overwhelming majority would rather pay extra to get their power from a "green" source. Although this poll did not ask exactly the same question as our concern, it does show how resolute people really are about renewable energy becoming a part of their world. (Incidentally, the City of Austin took that poll because their municipal utility is going to install rooftop PV on some of their customers' homes, and they wanted to make sure there would be public acceptance of the additional costs.)

For now, Davis' program is moving forward, albeit a little slowly. As in most cities, projects like these are passed on to special committees. Tim tells me that he has found a Natural Resources Commissioner that is excited about the project, but is also a very busy person. Hopefully the project will be under way soon.

We at Home Power are hoping that a few communities will get these RE programs going so they may serve as an example for other communities to easily follow. If you know of any communities that are considering a program like this, please let me know.

### Good Thing from Congress

I've done a lot of Congress-bashing over the years, so I'm pleased to announce that I've found an instance where Congress has done the right thing and for the right reasons!

Atomic fusion reactor funding has been cut from the DOE's budget. Scientists on both sides of the issue say fusion would work eventually, but after more than 40 years and almost \$14 billion spent, the experiments still have not produced a sustained reaction. The U.S. Congressional Research Service estimates that success is still 45 years and \$30 billion away. To top it off, fusion power reactors would produce even more radioactive waste than Advanced Light Water Reactors (fission). With the help of activists, economists, the media and scientists from across the nation, budget money for a fusion reactor has been killed in Congress. Many thanks to Jim Adams and others at the Safe Energy Communications Council for their hard work on this important project.

Now, if we can just get Congress to cancel some other programs, as well: Advanced Light Water Reactor R&D (fission reactor technology, funded at \$40 million for Fiscal Year 96), Nuclear Technology R&D (nuclear materials reprocessing, funded at \$18 million in the

House and \$40 million in the Senate), National Ignition Facility (laser technology to assess nuclear weapons effects and understand the physics of nuclear weapons design, funded at \$33.6 million in the House and \$71 million in the Senate; but projected to cost over \$4 billion to construct and operate.), Coal R&D (hey, this is a mature industry so let them fund their own research, funded at \$126 million in the House and \$113 million in the Senate).

The whole point of our government funding technologies for public use is to give potentially good ideas a start. The nuclear, coal, oil, and gas industries are mature industries and no longer need government R&D and start-up funds. On the other hand, solar, wind, hydrogen and other renewable technologies are young and underdeveloped and could really use a hand. If we're going to give subsidies, let's put them to better use.

### Access

Author: Michael Welch, c/o Redwood Alliance, PO Box 293, Arcata, CA 95521. (707)822-7884 voice, (707)822-8640 computer BBS, Internet: michael.welch@homepower.org

Safe Energy Communication Council, 1717 Massachusetts Avenue, NW Suite 805, Washington, DC 20036 (202)438-8491



5447 S. Swadley Ct.,  
Littleton, CO  
80127

Office 303/979-1899  
FAX 303/979-1577

**Solar Energy Resources**  
PHOTOVOLTAIC SYSTEMS & COMPONENTS

**CONSIDER THE FACTS:**

1. We specialize in solar electric systems
2. Custom installation available
3. Sales and Service
4. Backed by largest solar equipment distributor in USA
5. Over 10 years experience
6. We Solar Power our own homes!
7. Catalogues on request
8. Authorized Onan Generator dealer
9. Propane refrigerators by Servel and high efficiency electric refrigerators
10. Kyocera Solavolt and Duravolt Solar Modules

**Welcome to — Mr Solar's Homepage**

<http://www.netins.net/showcase/solarcatalog/>

## SOLAR INDUSTRY JOURNAL

camera ready

b&w

3.5 wide

4.85 high

## *Power Anytime!* *with the Solar Systems SS1000*

Run electrical appliances with the light of the sun. Perfect for emergencies, power failures, camping, recreation, work at remote locations, onboard boats, and for powering lights, computers, printers, radios, TVs, VCRs, and telecommunications anywhere. The SS1000 comes complete with flexible, lightweight, (1.5 lb.) solar panel, 12 Volt battery, and 100 watt ac inverter. Can also be charged from 120 volt household outlet.

\$475 plus \$22 shipping and handling.  
Calif. residents add 8.25% sales tax \$39.00

**Call (805) 563-2687**

**Solar Systems LTD**

**32 W. Anapamu St. #257, Santa Barbara, CA 93101**



- **DESIGNERS & BUILDERS OF HIGH-PERFORMANCE HOUSING**
- **DEALERS AND INSTALLERS OF MASONRY STOVES**

- pre-fair masonry stove workshop June 20-21 at the MREA fairgrounds featuring ALBIE CORE & ENVIROTECH STOVES

## **GIMME SHELTER**

**PO BOX 176 • AMHERST, WI 54406**

**715-677-4289**

## **Self-Reliant Intentional Communities**



## **COMMUNITIES**

Journal of Cooperative Living

Articles on self-reliant communities, ecovillages, cohousing, and more, by long-time community members and founders. Communities seeking members in North America and abroad. Quarterly, \$18 year • \$5 single issue.

*Communities*, Rt 4, Box 169, Louisa VA 23093; 703-894-5126

## **MicroHydro Specialists**

*14+ yrs. living with MicroHydro*

**Makers of "Lil Otto" Hydroelectric Systems**

*"He's a hard worker who doesn't drink very much!"*

Lil Otto is a permanent magnet hydroelectric generator. He works with as little as 1.2 GPM or Heads as low as 20 feet. 12 or 24 VDC output, up to 5 Amps. Comes complete with manual and right nozzle for your site.



**\$410. shipped free in Continental USA**

CA residents add 7.25% sales tax.

Dealer inquiries invited.

**Lil Otto Hydroworks!** Bob-O Schultze KG6MM  
POB 203, Hornbrook, CA 96044 • 916-475-3401

Home

&

Heart

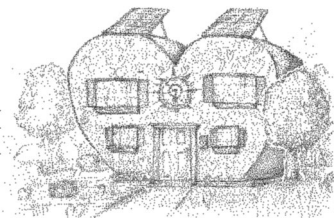

## Kathleen Jarschke-Schultze

It's been a busy summer at the creek this year. It was a great water year so we are still getting power out of the microhydro unit. Got a few more fruit trees in and planted nine grapevines. We're in the middle of changing out all the rest of the old windows in our ranch house to double paned low-E ones.

### Water, water

Our whole region was blessed by a late, wet spring and (unheard of) occasional showers throughout the summer. We have been getting power off the microhydro in the (usually) seasonal creek all year. The amount of power has diminished with the fall of the creek's water level. Still, this is only the second time this creek has run all year since we've been here.

### Fruitful

Since it was such a wet spring Bob-O and I decided to add some fruit trees to our small orchard. We decided on a dwarf Comice pear for canning and drying and a Santa Rosa plum. As part of the nice wet weather it was raining and sometimes freezing when all the fruit trees were in blossom. Consequently, the harvest is not big this year. Our peaches, Asian pear and Damson plum had but one fruit between them.

Our friends Bob and Golda Maynard gifted me with some fig trees this spring. I have eaten a ripe fig off of one. Another one has about ten figs which we are watching closely for signs of ripeness. I will have to keep the fig trees in the greenhouse for as long as possible as we are just too cold for them here. I now have the fig trees in the fenced garden area. Our dog, Amelia Airedale, was sneaking up on the potted trees and, bit by bit, nibbling any leaf she could reach down to the nub.

### The Grapevines

I grew up in the Napa Valley surrounded by vineyards. I like grapevines. Greek dolmas are a very good dish for solar ovens. I wanted a grape arbor. This spring Karen and I met Bob-O at a local nursery (we were all in town at the same time) to pick out the bare root vines. We had decided on all seedless, with black, red and white varieties. Our choice was Interlaken (white), Flame (red) and Glenora (black). It was the very end of bare

root season and some of the vines had already been potted for sale next year. We bought two of each variety and the guy at the nursery gave us one each extra in case some didn't survive.

Of course we hoped this was getting three vines for free. We reconfigured our original plans to include all nine vines. The arbor is in a U shape. While Bob-O was rototilling the shape and size we had calculated he hit a large rock (as big as a round laundry basket). He said, "Where do you want the rock?" He had the big pry bar in hand. "Just pry it out of the arbor room." I said. He looked at me mournfully. "That's up hill." he pointed out. "Fine," I said, "Just pry it into the arbor room. It can add sculptural interest."

Back that same day at the nursery we had picked out a greeny-gold happy Buddha for the garden. After we had planted all the vines I brought it to sit by the rock. It looked great.

We planted two of the Glenora across from each other at the front opening, then two Flame, then two Interlaken. The back row is Glenora, Interlaken and Flame right to left. We carefully planted each vine and waited for signs of growth.

Several weeks later all the vines except the Flame in the back row had new bright green leaves on them. That poor Flame looked like a dead stick if I ever saw one. That corner looked forlorn so Bob-O put the happy Buddha over by the dead plant. I planted wildflowers between the vines. After a couple of months we quit checking the Flame for life and just figured we would replace it in the spring.

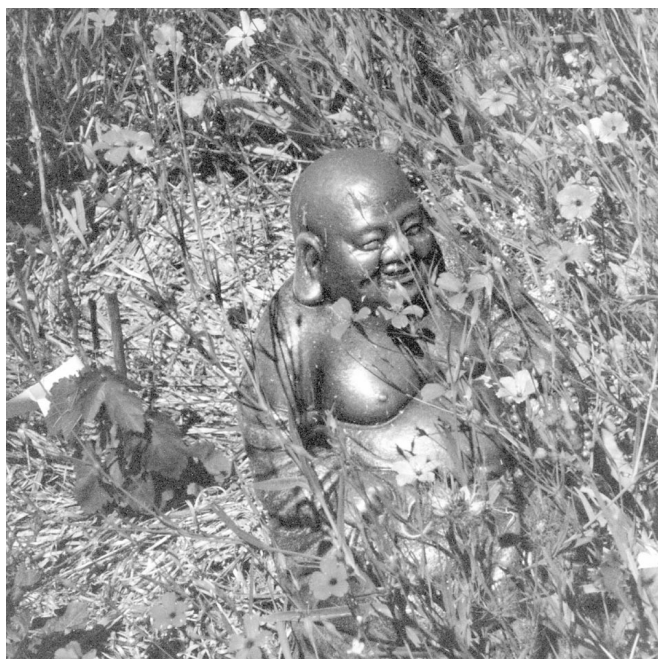

The wildflowers are blooming now. The colors are so bright and wonderful. They are taller than the new vines. We have timers on a micro sprinkler system. The only time we see the vines is when we weed every so often.

So Bob-O goes out to weed the arbor and the dead vine is growing. It has to have been growing for a while, but we haven't seen it. I notice that the Buddha sitting by it shades the vine from the afternoon sun. The Buddha is smiling.

### Ranch House Retro

We started replacing the old single pane windows in our house two years ago. The big 8' by 5' picture window in the living room was the first to go. By getting the double pane low-E replacement we noticed a five degree difference in overnight temperatures. The back bedrooms had their windows replaced next, needing it the most. The rest of the windows are on order, to be changed before winter.

Bob-O put two of those roof top turbine fans on to ventilate the attic space. He also placed soffit vents on the overhang. With only six square feet of attic left to reinsulate he has almost completed the attic project. We've already noticed a difference in keeping the house cooler on hot days.

### The Mud Room

Our old back porch was literally falling down. We rebuilt it into a mud room. There is a bench on the wall that can be opened to reveal the firewood box. This box can be filled from the outside. We used the old windows taken from one bedroom to provide light and circulation. The room has access from the deck, the

driveway and the house. Finally, a place for all the muddy gumboots, dripping coats and fishing poles. I'm in heaven.

### Garlic Garden

All 23 varieties of garlic are harvested. Each separated into its own bunch with its metal marker tied to it. That is the best way I have found to keep them separate from each other. I plant two rows of shallots between each variety to further delineate them. The shallots can be planted at the same time as the garlic and respond very well to the same schedule and treatment.

Already it is time to prepare the new garlic beds for planting later this month. It is best to use your biggest prettiest heads for seed. It really pays off at harvest time. Everything else ends up in the kitchen.

I've been picking the top leaves off of the basil and using the garlic to make pesto. I like to use almonds instead of pine nuts. Then I freeze it in ice cube trays. When frozen the pesto cubes are put into a large freezer bag. This makes it so easy later to drop a couple cubes into an Italian sauce or make a fast pesto noodle dinner or thaw it and spread it on sourdough French bread and broil it. Just be sure to wash those ice cube trays well because the olive oil tries to stay around to flavor the ice cubes.

### Access

Kathleen Jarschke-Schultze is feeling like Aseop's grasshopper at her home in northern-most California, c/o Home Power Magazine, POB 520, Ashland, OR 97520 916•475-0830 Internet Email: kathleen.jarschke-schultze@homepower.org or kjs@snowcrest.net



## Adopt a Library!

When Karen and I were living with kerosene lamps, we went to our local public library to find out if there was a better way to light up our nights. We found nothing about small scale renewable energy.

One of the first things we did when we started publishing this magazine seven years ago was to give a subscription to our local public library.

You may want to do the same for your local public library. We'll split the cost of the sub (50/50) with you if you do. You pay \$11.25 and Home Power® will pay the rest. If your public library is outside of the USA, then we'll split the sub to your location so call for rates.

Please check with your public library before sending them a sub. Some rural libraries may not have space, so check with your librarian before adopting your local public library. Sorry, private or corporate libraries are not eligible for this Adopt a Library deal—the library must give free public access. — Richard Perez

To Adopt a Library write or call

**Home Power®**

PO Box 520, Ashland, OR 97520

1-800-707-6585 or 916-475-0830 or FAX 916-475-0941

# HAPPENINGS

## CANADA

Environment and Energy Conference of Ontario, October 31 - November 2, 1995 at the Metro Toronto Convention Centre, will also include the Annual Conference of the Solar Energy Society of Canada.

Papers/abstracts/presenters are requested on a wide spectrum of topics including sustainable transportation, agriculture, chemistry, business. Ask for complete info from Roger Scott 416-323-5879 or Kirsten Mania 416-323-4675; or write: 1995 EECO, Ministry of Environment and Energy, 11th Floor, 135 St. Clair Ave. W, Toronto, ON M4V 1P5, Canada; Fax: 416-323-4322.

The "Alberta Sustainable House" is now open for public viewing every Saturday 1:00-4:00 PM free of charge. The first of its kind in Canada, the project emphasizes cold-climate state-of-the-art features/products based on the founding principles of occupant health, environmental foresight, resource conservation, AE, recycling, low embodied energy, self-sufficiency, and appropriate technology. Already in place: R17 window, multi-purpose masonry heater, solar hot water, greywater heat exchangers, LED and electroluminescent lighting, solar cookers, and others. Under development: hydrogen fuel cells, Stirling co-generator, Tesla bladeless steam turbine, and others. Contact: Jorg Ostrowski, Autonomous & Sustainable Housing Inc/Alternative & Conservation Energies Inc, 9211 Scurfield Dr NW, Calgary Alberta T3L 1V9, Canada; 403-239-1882, Fax: 403-547-2671.

The Institute for Bioregional Studies was founded to demonstrate and teach recent ecologically-oriented, scientific, social and technological achievements that move us toward ecological, healthy, interdependent and self-reliant communities. For more info: IBS, 449 University Ave, Charlottetown, Prince Edward Island C1A 8K3, Canada; 902-892-9578.

## FRANCE

13th European Photovoltaic Solar Energy Conference and Exhibition, Nice, France, 23-27 October 1995. For more info contact Dr. H Ossenbrink, EC-Joint Research Centre, European Solar Test Installations/ESTI, 1-21020 Ispra (VA), Italy; Phone: 39-332-789 172, Fax: 39-332-785 561 or 39-332-789 268. For proceedings of the 12th Conference write: H.S. Stephens & Assoc, Pavenham Rd, Felmersham, Bedford MK43 7EX, England.

## JAPAN

World Energy Council 16th Congress, Energy for Our Common World October

8-13, 1995 in Tokyo, Japan. For more information contact: WEC Toyko Congress Organizing Committee, Tel. + 81-3-3437-4821, Fax +81-3437-4678

## MONACO

Born from its traditions of autosports and a beautiful environment, the first Monte-Carlo Rendezvous of Electric Vehicles will occur October 19-22. The Salon portion will bring together manufacturers, distributors, dealers and servicers of EVs with press, schools, municipalities, etc. The Rallye portion will feature sports/entertainment personalities and leading EV drivers for a media-filled event of the latest technologies. To participate, drive or exhibit, contact: Sylvie Boutinot, Editions & Promotions Internationales, 11, Boulevard Albert-I-ER™, Phone: 92-16-03-76, Fax: 93-15-03-13

## NATIONAL

Energy info on the Internet can now be accessed via the Energy Efficiency and Renewable Energy Network (EREN), a multimedia WWW server developed by the DOE. Check it out at <http://www.eren.doe.gov> or contact: Energy Efficiency and Renewable Energy Clearinghouse, PO Box 3048, Merrifield, VA 22116; 800-363-3732; e-mail: ENERGYINFO@delphi.com

"Learning to be Water Wise and Energy Efficient" curriculum with materials for classrooms and home schools is now available from National Energy Foundation, 5225 Wiley Post Way #170, Salt Lake City, UT 84116; 801-539-1405, Fax: 801-539-1451.

American Hydrogen Association Bulletin Board System: Solar Hydrogen BBS, 415-494-3116, 1200-14,400 baud V.32bis. V.42bis 8N1; also, Prosperity without Pollution: AHA Tempe BBS 602-894-8403.

Energy Efficiency and Renewable Energy Clearinghouse (EREC) is offering info on Heat Pumps for homeowners interested in how a heat pump works, selecting and maintaining a heat pump, and innovations in heat pump technology. Also available is information on landscaping for energy efficiency. Contact EREC: Phone: 800-DOE-EREC (363-3732); mail: EREC, PO Box 3048, Merrifield, VA 22116; e-mail: [energyinfo@delphi.com](mailto:energyinfo@delphi.com); TDD: 800-273-2957; BBS: 800-273-2955.

The Learning to Water Wise and Energy Efficient is a program designed for children, grades 4 thru 8 to teach tomorrow's energy consumers wise habits that they can use for many years to come. Not only do teachers

and students receive the instructional materials to learn the concepts and principles of conservation, but they also receive the hardware they need to apply what they have learned. The program is sponsored by local utilities or companies that want to make an environmental difference in their community. For information on helping implement the program in your community contact: Sarah Quarante, Energy Technologies Laboratories, 2351 Tenaya Dr, Modesto, CA 95354,, 800-344-3234. fax 209-529-3554.

The third National Tour of Independent Homes will be held Saturday, October 14, 1995. Anyone interested in participating or in touring the homes in their area call 800-762-7325

The U.S. Department of Energy's Office of Building Technologies (OBT) through NREL (National Renewable Energy Laboratory) is offering bulletins describing current research in heating, ventilating and air-conditioning (HVAC) that is being conducted by OBT and its labs. The free bulletins are "Thermally Activated Heat Pumps", which discusses efficient gas-fired heat pump technology that heats and cools buildings without producing CFCs. Also, HBCU Program at Tennessee State University discusses research in alternative refrigerants. Limited quantities of these bulletins are available by contacting NREL's Document Distribution Service at 303-275-4363, fax 303-275-4053 or [evanss@tcplink.nrel.gov](mailto:evanss@tcplink.nrel.gov) (e-mail).

## ARKANSAS

Sun Life is now conducting "Third Saturday Seminars" on inexpensive building techniques. Their focus is to teach home building from materials that can last a thousand years and cost less than conventional wood-framing. These are hands-on, all-day workshops. Contact Loren at PO Box 453, Hot Springs, AR 71902.

May 10-17, 1996, the 8th Annual American Tour Sol. Road rally championship for electric and solar cars from New York to Washington, DC. For more information: NESEA, 50 Miles St, Greenfield, MA 01301, 413-774-6051, fax 413-774-6053.

## ARIZONA

The State of Arizona is now offering a tax credit for installation of all types of solar energy systems. A solar technician certified by the Arizona Department of Commerce must be on each job site. For info contact ARI SEIA; 602-258-3422.

## CALIFORNIA

Offline Independent Energy Systems Workshop: Designing Your Home PV Power System for Beginners—Sunday October 22, 1995. The class will begin with a tour and discussion of our own PV system, which includes water pumping and telecommunications. We will then develop

the following topics: basic systems types, determining power needs, the PV array, the battery, and inverters. We will discuss how it's all put together such as any special wiring needs, code requirements and safety, instrumentation and controls. We will also look at how to LIVE with PV in relation to appliances, computers, and entertainment equipment, attitude and awareness. The workshop will be held at the Offline home/office about an hour from Fresno, California in the Central Sierra. Cost is \$35 per person or \$45 for two together. For further information, reservations and directions, please call, write, or e-mail Don and Cynthia Loweburg, Offline Independent Energy Systems, PO Box 231, North Fork, CA 93643, 209-877-7080. internet ofln@aol.com

Siemens Photovoltaic Training Workshop, intensive five-day seminar, will be held October 16–20. For more info contact Cindy Vernon, Siemens Training Department, 4650 Adohr Lane, Camarillo, CA 93010; 805-388-6585, Fax 805-388-6395.

An Electric Vehicle Workshop will be given in Fort Bragg, November 18-19. Topics covered include design, components, maintenance, safety, and many others. Contact Burkhardt Turbines, 1258 N Main St, #B2B, Ft Bragg, CA 95437; 707-961-0459.

California Air Resources Board (CARB) "routine, continuous review" of the 1998 ZEV mandate (2% of cars sold must be EVs) and holds forums, usually at their Mobile Source Division, Annex IV, in El Monte. Dates and subjects: October 11-Technology Review (focus on batteries, incl. staff and industry presentations); November 8-Benefits and Costs of EVs (incl. staff presentations). Contact: Air Resources Board, 2020 L St, Sacramento, CA 95814; 916-332-5840.

The Northern California Solar Energy Association is offering two workshops this fall on passive solar design strategies for home. The first workshop will be held October 28, 1995 in Santa Rosa, CA and the second is October 30, 1995 in Santa Maria, CA. To receive registration materials please call 510-869-2759 and leave your name and address.

Electric Vehicle Workshop, Saturday, October 28, 1995, 10 am to 5 pm, at Cabrillo College in Aptos, CA, Fee, \$65. This workshop is for do-it-yourselfers who are interested in converting a car to electric, as well as anyone who is interested in EVs. Workshop instructor is Michael Brown, a nationally recognized expert on electric car conversion. For more information contact: Michael Arenson, 408-423-8749.

SMUDs Brown Bag Series IX. Bring your lunch and enjoy a free presentation. Oct. 17,

Using post-consumer recycled materials;; Nov. 14, Passive solar architecture & residential design; Nov. 28, The four basics; Dec. 12, SMUDs habitat for humanity project. For more information call 916-732-6835.

Encampment to Save Ward Valley from a Nuclear Waste Dump, October 10–15, 1995. Join the celebration of the beautiful Mojave Desert and to protect endangered species and Native American Rights. Ward Valley is located 22 miles west of Needles, CA. The Nuclear Industry plans to bury long-lasting and highly dangerous radioactive wastes from nuclear power plants in shallow, unlined trenches above an aquifer and just 18 miles from the Colorado River. Ward Valley is directly adjacent to the new Mojave National Preserve and is surrounded by five wilderness areas. Area Indian tribes consider Ward Valley sacred homeland and have vowed to defend their traditions, land, water and culture. Secretary of the Interior Bruce Babbitt has announced his intention to transfer the land at Ward Valley to the state of California. Once California Governor Wilson, who is in favor of the dumps, has control of the land dump construction could begin in a few months. Community meals, water and sanitation provided. Come prepared for desert camping. We will walk lightly in the land and leave no traces. We are asking for a \$15 donation in advance, \$20 at site. No one turned away for lack of funds. Participating groups: Ward Valley Coalition, GreenPeace, Fort Mojave Indian Tribe, Toxic Links Coalition, California Communities Against Toxics (CCAT), Bay Area Nuclear (BAN) Waste Coalition, Alliance for Survival, Americans for a Safe Future and others. For more info, registration forms, and to volunteer call: 415-752-8678, 714-547-6282 or 800-454-3016.

### **COLORADO**

Solar Home Design, October 9–27; Straw-bale, Adobe & Rammed Earth Building, Weekends in October. Contact Solar Energy International, PO Box 715, Carbondale, CO 81623, Phone 303-963-8855, Fax 303-963-8866.

Solar Energy International (SEI) is offering workshops on the practical use of solar, wind, and water power. The 1995 Renewable Energy Education Program (REEP) features one and two week workshops: Solar Home Design, Environmental Building Technology, PV Design & Installation, Advanced PV, Solar Cooking & Biofuels, Micro-Hydroelectric Systems, and Wind Power. Guest speakers and professional instructors will teach the design of state-of-the-art solar homes that are self-reliant, energy efficient, healthy to live in, and earth-friendly. Participants will learn the knowledge and skills to build energy-independent homes with solar, wind, and water power. The series is for owner-builders, industry technicians,

business owners, career seekers, and those working in developing countries. The workshops may be taken individually or as part of a program. The cost is \$400 per week. Scholarships and work/study programs are available on a limited basis. Contact: Solar Energy International, PO Box 715, Carbondale, CO 81623 or call 303-963-8855.

Visit the new National Wind Technology Center operated by the National Renewable Energy Laboratory, just outside of Golden. Facilities assist wind turbine designers and manufacturers with development and fine-tuning and include computer modeling and test pads. Call in advance, 303-384-6900, Fax 303-384-6901.

### **CONNECTICUT**

Renewable Energy in A Competitive Environment: A Biomass Focus; October 12, 1995, 8:45 am to 3:30 pm at New England Air Museum, Windsor Locks, CT. Sponsored by State of Connecticut, CONEG, US DOE. No registration fee but pre-registration is urged for a lunch count (no cost lunch). For more information contact: Virginia Judson, OPM/Energy, 80 Washington St., Hartford, CT 06106, 203-566-2047 or Joel N. Gordes at 203-379-2430

### **GEORGIA**

Georgia Tech is sponsoring the Global Environment Conference for developers, architects, and engineers on environment-friendly building construction, and sustainable design and development on November 2-3, 1995 in Atlanta, GA. For more info contact Angela Arnold at 404-894-3068.

### **MASSACHUSETTS**

The Seventh Annual Sustainable Transportation and S/EV95 (Solar & Electric Vehicle) Symposium, Boston, MA, November 13-15, 1995 (exact location to be announced) will bring together a broad coalition of transportation planners, electric and hybrid electric industry representatives, business people, policy makers, and engineers to foster the growth of a viable electric vehicle industry, and the development of a sustainable transportation vision for the nation. In-depth workshops, concurrently held sessions and an extensive trade show have made the event the major electric vehicle conference in the United States. For more information contact: NESEA, 50 Miles St, Greenfield, MA 01301, 413-774-6051, fax 413-774-6053.

On March 4–6, 1996 in Boston, MA, NESEA will bring you the results of a 15 nation project to optimize solar electric buildings in a powerful combination with RENEW '96 and the 12th Annual Quality Building Conference. This triple event will bring together forward thinking building and energy professionals to discuss ground breaking research and real world projects in healthy, resource efficient construction,

## Happenings

distributed generation and grid scale renewable energy production, transmission and management. For more information contact: NESEA, 50 Miles St, Greenfield, MA 01301, 413-774-6051, fax 413-774-6053.

### NEW YORK

The New York State Electric Auto Association (NYSEAA) is dedicated to sharing current electric vehicle technology. Monthly meetings, for date and location call Joan at 716-889-9516

### NORTH CAROLINA

SOLAR '96, National Solar Energy Conference, featuring the 25th ASES Annual Conference and the 21st National Passive Solar Conference, April 13-18, 1996, Asheville, NC. For more information contact, American Solar Energy Association, 2400 Central Ave Ste G-1, Boulder, CO 80301

### OHIO

Solar electric classes taught at rural alternative powered home with utility backup. Maximum of 12 students. Must advance register. \$40 fee per person, \$45 per couple. Lunch is provided so please advise of dietary restrictions. Class #1 will be full of technical info, system sizing, and NEC compliance, etc. Students will see equipment in use. Class #2 will set-up a system (hands-on), equipment selection, installation of modules and balance of system. Dates: Oct. 14, Nov. 11, & Dec. 9. All classes held from 10 AM to 2 PM on Saturday. Call 419-368-4252 or write Solar Creations, 2189 SR 511 S, Perrysville, OH 44864-9537.

The Great Lakes Electric Auto Association's mission is to contribute to the freeing of the US automobile market from dependency on petroleum through advancements in electric and hybrid/electric technology. For more information contact, Larry Dussault, GLEAA, 568 Braxton Pl E, Westerville, OH 43081-3019, 800-GLEAA-44 or 614-899-6263, Fax 614-899-1717. Internet address: DUSSAULT@delphi.com

### OREGON

The Solar Energy Association of Oregon (SEAO) presents Agenda Solar '95, New Ideas for Building the Future, Saturday, October 14, 1995 at Portland State University, Portland, OR. Topics include: Energy policy, sustainable utilities, recycled

materials, alternative construction (straw bale), photovoltaics for the home, sustainable development, & electric vehicles. For more information contact SEAO, 418 SW Washington Ste 306, Portland, OR 97204, 503-224-7867

Aprovecho Research Center has three internship openings for Fall term. Interns study organic gardening, sustainable forestry and appropriate technology. Help bring in the seasons crop, do some horse logging, finish testing a new solar thermal pump, desalinators, solar dehydrator and solar refrigerator. Cost is \$500 per month, includes room and board, classes 8:30 to 5:30 daily. Contact Aprovecho at 80574 Hazelton Rd., Cottage Grove, OR 97424 or call (503) 942-8198.

### WISCONSIN

The Midwest Renewable Energy Association Fall 1995 Workshop schedule: October 7-8 in Amherst, WI, Detailing for Energy Efficiency; instructor, Mark Klein, Gimme Shelter; cost is \$200; Includes residential siting, passive & active solar design, hydronic heating, energy efficient & environmentally friendly materials, super insulation construction methods and daylighting. October 14-15 in Amherst, WI; Wind/Photovoltaic Hybrids; Instructor Mick Sagrillo and Jim Kerbel; cost \$200; prerequisite, basic knowledge of electricity; includes siting, electrical usage calculations, system sizing and balance, charge controllers, high voltage transmission, tower designs, installation methods, and hands-on projects. October 20-22 at Treehaven Learning Center in Tomahawk, WI; Batteries and Inverters; instructor, Bob-O Schultze, Electron Connection and staff member of Home Power; cost \$250; prerequisite, basic knowledge of electricity; includes battery types, chemistry, characteristics and performances, installations, maintenance, safety; inverter types, performance, characteristics, and installation, demonstrations of batteries, inverters and test equipment, emphasis on Trace 4000 watt sinewave inverter. October 28 in Madison, WI; Residential Solar Energy; instructor, Doug Steege, Altech Energy; cost is \$100; covers solar heating and home design, active and passive systems, collection and storage systems, conservation and insulation, air-to-air heat exchangers,

and moisture barriers. November 4 in Amherst, WI; Insulated Window Coverings cost is \$40; instructor, Beverly Nelson; prerequisite, basic sewing skills or desire to learn; addresses residential window treatments (insulation), focusing on making the coverings, coverings in various stages of completion will be used to demonstrate construction methods. For more information call the Midwest Renewable Energy Association at 715-824-5166 or write to PO Box 249, Amherst, WI 54406.



HITNEY SOLAR  
camera ready  
b&w  
2.25 wide  
5 high

## Powerhouse Paul's Stream Engines™ Small Scale Water Power Equipment

### FIRST TO MARKET:

- Small Turgo Turbines -
- Low Head High Flow Machines -
- Induction Generators -
- Brushless Alternators -

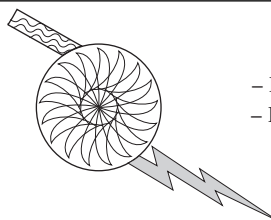

### IN BUSINESS SINCE 1980

- operates on heads of 4 feet to over 400
- Battery voltage or high voltage for long distances
- Pelton and turgo turbines runners sold separately

### ENERGY SYSTEMS & DESIGN

P.O. Box 1557, Sussex, N.B., Canada E0E 1P0  
506-433-3151



# The Midwest Renewable Energy Association

## Fall 1995 Workshop Schedule

### October 7-8: Detailing for Energy Efficiency

Instructor: Mark Klein, Gimme Shelter

Location: Amherst, WI

Cost: \$200

Includes residential siting, passive & active solar design, hydronic heating, energy efficient & environmentally friendly materials, super insulation construction methods and daylighting.

### October 14-15: Wind/Photovoltaic Hybrids

Instructors: Mick Sagrillo and Jim Kerbel

Location: Amherst, WI

Cost: \$200

Prerequisite: Basic knowledge of electricity.

Includes siting, electrical usage calculations, system sizing and balance, charge controllers, high voltage transmission, tower designs, installation methods, and hands-on projects.

### October 20-22: Batteries and Inverters

Instructor: Bob-O Schultze, Electron Connection and staff member of *Home Power*®

Location: Treehaven Learning Center, Tomahawk, WI

Cost: \$250

Prerequisite: Basic knowledge of electricity

Includes battery types, chemistry, characteristics and performances, installation, maintenance, safety; inverter types, performance, characteristics, and installation. Demonstration of batteries, inverters and test equipment. Emphasis on Trace 4000 watt sinewave inverter.

### October 28: Residential Solar Energy

Instructor, Doug Steege, Altech Energy

Location: Madison, WI

Cost: \$100

Covers solar heating and home design—active and passive systems, collection and storage systems, conservation and insulation, air-to-air heat exchangers, and moisture barriers.

### November 4: Insulated Window Covers

Instructor, Beverly Nelson

Cost: \$40

Location: Amherst, WI

Prerequisite: basic sewing skills or desire to learn them.

Addresses residential window treatments (insulation), focusing on making the coverings. Coverings in various stages of completion will be used to demonstrate construction methods.

*MREA is a non-profit educational organization whose mission is to promote renewable energy and energy efficiency. Become a MREA member before November 20th and your name will be entered in our Membership Prize Drawing. Call for details of Prize Drawing, membership benefits, and prices.*

For more information call or write

**The Midwest Renewable Energy Association**

**PO Box 249, Amherst, WI 54406 • 715-824-5166**



## What Are You Missing?

### Need some back issues of Home Power?

*If you don't know what you're missing, check out the index in HP#48. Issue 48 contains an index of articles in issues #1-#47.*

You can buy them individually:

\$3.25 each for #11, #13, #14, and #16 through #20

\$4.75 each for #21 through #45 (except for #36)

\$5.75 each for #46 through #49

Or

Deal #1: buy all 35 available issues for \$108

Deal #2: buy 6 or more issues (of #21 through #48) for \$4.00 each (sent bound printed matter).

*for U.S. ZIP codes only, see page 81 for international back issues.*

(Sorry, we're out of issues 1 through 10, #12, #15 and #36). We are planning to compile them into a book. Until then, borrow from a friend. If you have a computer (or a friend with one) download the article you're missing by calling the Home Power bulletin board at 707-822-8640. Or check with your local library; through interlibrary loan, you can get these back issues. Jackson County Library in Oregon has all issues as does the Alfred Mann Library at Cornell Univ.)

Home Power, PO Box 520, Ashland, OR 97520 • 800-707-6585 • 916-475-0830 VISA / MC



## the Wizard speaks...

### Transmutation

Since time immemorial alchemists and scientists have been chasing the elusive processes of elemental transmutation. This is the changing of one element into another by chemical and other means. In the Middle Ages, the main goal was the transmutation of base metals (usually lead) into silver and gold. With the advent of nuclear reactors and particle accelerators much of this can now be accomplished. However, yields are small, efficiencies low, and costs high.

In certain cold fusion experiments, the transmutation of electrolyte components has been observed. Recently, transmutation products have been found in the metallic lattices of cold fusion cells. Both gold and silver have been found, especially when using palladium electrodes.

The results of experiments in other fields have verified the existence of low temperature, non-radioactive transmutation. The methods involve electromagnetic field structures, temperature control, and other processes. Metals such as lead, iron, copper, and aluminum have been transmuted into various other metals including silver, gold, and platinum.

Finally, anomalies in certain biological processes suggest that transmutation at low temperatures and energies occurs in nature. It seems that certain naturally occurring vegetable life can effect elemental transmutation under the proper conditions.

We may be on the verge of discovering one of the major secrets of the physical universe. The Anything To Anything machine may be in our future.



### SANDERSON'S REBUILT VACUUMS

Specializing in 3 & 4 AMP Kirby's  
Lower amperage Kirby's are the ultimate in chore relief -  
kind to your batteries and back alike.

**3 AMP - \$175**

**4 AMP - \$150**

For More Information Call (408) 628-3362  
Or Write: 20295 Panoche Rd., Paicines, CA 95043

## SOLAR CHEF®



The Solar Chef will cook or bake any food under the Sun and do it in conventional cooking times. (capable of 500°F)

**THE HEALTHIEST WAY TO COOK—FOR YOU & THE PLANET**

FOR MORE INFORMATION



CALL 503-471-6065



220 SOUTHRIDGE WAY, GRANTS PASS, OR 97527

**Get out of the kitchen and into the sun!**

### Heaven's Flame

*a Guidebook to Solar Cookers by Joseph Radabaugh*

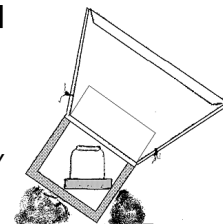

Joseph Radabaugh's book of 96 pages with 11 photographs and 50 illustrations, provides plans to build an inexpensive, efficient solar oven from foil, glass, and cardboard boxes. Full color cover and durable binding. For under \$15 (including the cost of the book) you can be cooking with the sun. Cook delicious food, save money on cooking fuels, and have more time to do the things you want to do.

Available for \$10 postpaid inside USA (Mexico - Canada add \$1, elsewhere outside USA add \$2 S & H).

Please allow four weeks for delivery  
Make check or money order payable to:

**Home Power Inc.**

POB 520, Ashland, OR 97520 • 916-475-0830  
VISA / MC

Now Available from Home Power

# Back Issues of *Alternative Transportation News* People • Technology • Sources • Interviews

Choose from these four issues:

June/August 91

September/October 91

November/December 91

August 92

\$3.50 each

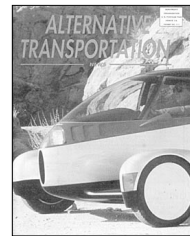
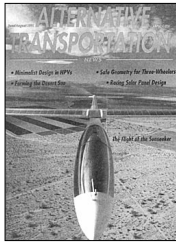

all four for \$3.00 each

International orders please add \$1.00 per issue

Available from Home Power, POB 275, Ashland, OR 97520.

Please make check payable to Home Power. For Visa or Mastercard orders please call 916-475-0830

## Go Solar Enterprises

Micro-Hydroelectric • Photovoltaic  
Wind Power

Site Analysis	Hardware Sales
System Sizing And Design	Installation
Consultation	Education

SERVING THE CENTRAL BLUE RIDGE MOUNTAINS

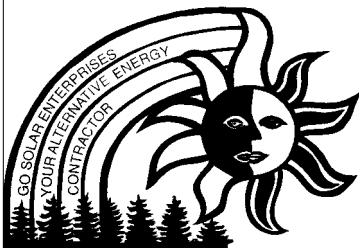

NC Electrical Lis #18133

**Joe M Flake**  
P. O. Box 422  
Richfield, NC  
28137  
704-463-1405

## RADIO

### C. CRANE COMPANY



#### Portable Power Pack

12 v- 7 AH Gell Cell

Complete with AC adapter, and lighter patch cord for charging.  
INCLUDED: Magnetic Light, 12,9,6, & 3 volt DC/DC stepdown with universal plug tips, Female lighter plug output jack.

Special introductory price \$159.95  
Price includes shipping Made in USA

OPTIONAL: Solarex 10 watt panel with lighter splitter \$143.95.

AM/FM, SHORTWAVE, SCANNER RADIOS/ANTENNAS AND BOOKS

**Please write or call for free catalog**  
558 10th Street, Fortuna CA 95540  
**1-800-522-TUNE (8863)**

*Satisfaction Guaranteed*

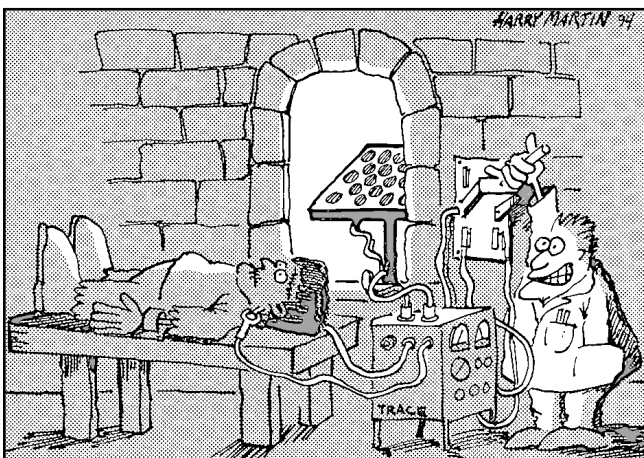

## Need a renewable energy quick-start for the ole' brain?

### Home Power Quick-Start Special

our last six issues and a one year surface subscription.

All for \$45 for US Zip Codes

Call for International Rates.

Home Power Magazine

P.O. Box 520, Ashland OR 97520 USA

916-475-0830 VISA or MC



formed electric utility districts each township could build its own locally owned and operated wind farm! I've been told federal loan dollars are available for these projects but I'm still researching that funding source. Before even considering this undertaking, I suggest each township conduct a "green pricing" survey to find out how many residents want to buy wind generated electricity and at what price. Surprisingly even if only 5% to 10% agree to pay, let's say three to five cents more for wind generated electricity the town can then size the wind farm accordingly and know what revenue stream to expect. Remember a municipal wind farm can begin with only one turbine of any size.

I suggest that each RE advocate check his/her local, county or state regulations as to what it takes to form a municipal utility district. I'd like nothing better than to see all 72 Wisconsin counties have at least one wind or PV farm in a township. Renewable energy produced, consumed and owned at the local level is RE at its finest! Michael Magan, Ecology Services & Products, PO Box 176, Delafield, WI 53018, 414-646-4664, fax 414-646-2457

*Hi Michael. Thanks for the report on the new openness to RE private investments! RE is beginning to make the headway we all have been envisioning for years.*

*Yes! Forming municipal utilities is a wonderful way to wean a community from the grid. And most folks are willing to pay just a little bit more for green electricity than for fossil fuel and nuclear. There have been recent polls which confirm this willingness. An additional benefit of forming municipal utilities is that there is no longer a need for the utility to make a profit—to be paid to its owners. That equals the possibility of even lower rates than ratepayers are used to. Local, decentralized power sources are much more efficient than transmitting power over hundreds of miles of high voltage transmission lines, and there's a lot to be said for having control over your own community's energy future. Michael Welch*

#### **Wind Power in Scotland**

Home Power Magazine, I am a windpower addict of long standing, having been obsessed with windmills since the late seventies. We have produced all our electricity from the wind since then, mostly using locally built machines, but I also have a secondhand Whirlwind 10 kW, which gives me much joy and pain. I am fascinated by Home Power, and I always read Mick Sagrillo's contributions with great interest. Here in the UK, wind turbines are pretty few and far between. Here at Scoraig there are plenty, but most other places are on the grid (as we call the utility). There are some exciting windfarm developments using big machines, and quite a few Marlec 'Rutlands' around, but very little in between.

We have a lot to learn from you, especially in terms of tower heights, which are usually pathetic here. Anything above 20 feet is regarded as frighteningly high, and above 40 feet is unlikely to get planning approval. American built windmills don't seem to last very long here, and it may be partly because the wind is much more turbulent at low levels. British windmills tend to be more heavily built, and expensive!

There are a few areas where I disagree with Mick. I hope you approve of healthy controversy in your pages. My main gripe

#### **Not Ogres**

I worked for a large public utility for 17 years. They are not the ogres as many portray in their articles and letters in HP. In fact, my company (private for-profit electric & gas co.) supported and publicized my efforts in the 1970's-80's in my research on alternative energy. I built a successful electric vehicle which they featured in an article, a successful solar water heater, and a not quite so successful wind generator. They were fully supportive even though some of my items would have diverted selling me energy. I think a more even-handed approach to criticism is called for. K. Hayes, Choske, MN

*Good point! Many private and municipal utilities are going the extra yard to try to make renewable energy a reality in their service areas. More (RE) power to them! Cases in point, Ashland Oregon municipal utility, and many munis and REC in Minnesota, Wisconsin, and Iowa. Utilities are publicly granted monopolies. They are what your PUC makes them. Your PUC is what YOU make it. Nuff said. Richard Perez and Michael Welch rant and rave for the Whole Home Power Crew.*

#### **Good News**

This past Midwest RE Fair '95 got so hectic I didn't get a chance to roam around and ask questions of the dozens of "experts" at the fair. I regret this a lot but decided to write and seek comment on my latest RE research project here in Wisconsin—development of locally owned, government financed wind farms.

In May I attended the North American Regulators of Utilities (NARUC) conference in Madison, WI. NARUC is a national group for state utility regulators. This annual conference was well attended and surprisingly very informative and farsighted. At the conference, a Prudential Insurance Company investor (he gets to spend your insurance payments) made a remarkable statement for a mainstream investment firm. He stated that Prudential Insurance now considers renewable energy (PV & wind), despite its present higher production costs, to be a more conservative investment (meaning good long term) than fossil fuel or nuclear derived electricity! This means RE has gained respect in the corporate investment field which could be both good and bad news but, that's another topic.

Wisconsin contains 72 counties each with a dozen or so townships. Each township in Wisconsin can vote to form a utility district which usually means providing municipal sewer and water, but may include electricity. If Wisconsin townships

is with his treatment of permanent magnet alternators. For many years, I used generators with wound field coils, but I would not go back to them now, even though they were cheaper, being secondhand. It is important to realise that field windings use an electric current to produce magnetism, whereas permanent magnets need no current. Admittedly, this current is taken from the generator output rather than the battery, but in the end the result is the same: the batteries miss out.

The generator needs magnetism to work. If this magnetism comes from a wound field coil which consumes 30 watts (say) then we get 30 watts less from the windmill than we would with a permanent magnet generator. It is argued that permanent magnet generators create too much magnetic drag, and it is true that this can be a problem during start-up, when the blades are running in stall. Once the operating speed has been reached though, this is not a problem. We need magnetism to make the generator work, and this will create no more drag just because it comes from a permanent magnet. Permanent magnet alternators are more efficient than wound field generators at low windspeeds, which is just when we are hungriest for power. If there is only 30 watts of power available in the wind, I hate to see it gobbled up by field windings!

I also take issue with Mick's definition of 'stall'. He equates stall with overspeed, where the blades cannot run any faster. True aerodynamic stall is the opposite. It occurs when the blades are running at less than their 'best' speed, relative to the wind. Stall is used for speed control on many of the big windfarm windmills, which are connect straight to the grid (sorry, utility). Grid connection means that the shaft speed is almost perfectly constant, although the windspeed and power output vary. As the windspeed increases, the angle of attack of wind on blade increases, until stall is reached, just like in an aeroplane. Stall causes a flattening off of performance in high winds which is very useful, but there will always be a higher windspeed where the windmill has to be shut down. If it begins to overspeed, then it comes out of stall, and disaster is almost inevitable.

Finally, there is the old chestnut about 3-phase AC being more efficient than DC in cables. This is a very common misconception. It is true that 3-phase AC is more efficient than single-phase AC, where a neutral connection is used. You can put three single-phase supplies together, using a common neutral wire, which hardly carries any current. The resulting voltage between the live wires is now higher by the root of three, and this explains how the improved efficiency is achieved. A 3-phase supply with 190 volts between live wires

Below: Wind power in Dundonnell Scotland. Photo by Hugh Piggott



is more efficient than three single-phase supplies at 110 volts, which it replaces. Each 110 volt outlet uses the one live wire and the neutral.

With a battery system, the neutral does not come into the picture. 3-phase AC is fed to a rectifier, and DC is produced, which has the same voltage as that between any two of the live wires. So the 3-phase supply is not at a higher voltage than the battery voltage. So it is no more efficient than DC current in the wires, in fact it is slightly less efficient than it would be to use the same amount of copper on DC transmission. I don't expect anyone to believe me, but this is the truth.

I shall strive for technical accuracy, although it will probably not make me any friends. Keep up the good work. Hugh Piggott, Scoraig, IV23 2RE, United Kingdom

*Hello, Hugh! Glad to hear you are still a faithful HP reader, even after our last go 'round. I, too, strive for technical accuracy. However, I have learned there are different points of view on many subjects, including technical issues. Two technicians approaching the same problem from different perspectives will invariably come up with different, yet comparable, solutions. We can agree to disagree, and still come to the same finishline together.*

*In reference to the Apple and Oranges article in HP #42, I still believe that permanent magnet (PM) alternators are a compromise when compared to generators utilizing wire wound fields. The output of a wind generator is a function of a number of design parameters, one of which is the flux density of the magnetic field. In a generator with a wire wound field, the flux density of the field varies as the output of the wind generator increases and decreases. The power input curve to the fields and the resulting power output curve of the wind generator nicely follows the power in the wind. This means that blades are always working at their maximum, design efficiency, extracting power out of the wind with minimum effort on their part.*

*PM alternators complicate the situation because the flux density of the PM field is always at its maximum. Flux density in a permanent magnet is not variable as it is in a wire wound field. As a result, the blades see their ideal load at only one point in the wind generator's power curve. At all other points, the blades are, in essence, fighting the magnetic field.*

*In my experience, the power output of a wire wound field generator is always superior to that of a PM alternator. I believe that this is due to the loading put onto a set of blades by the flux density of a well designed wire wound field. As an example, I offer a 3 kw Jacobs compared to a 3 kw Whisper wind generator. The Whisper reaches its rated output of 3 Kw in a 25 mph wind speed, and does it with a 14.8 foot rotor having a swept area ( $\pi \times \text{radius squared}$ ) of 172 square feet. The Jacobs reaches the same output in a 23.5 mph wind with a 14 foot rotor having a swept area of 154 square feet. At 28 mph, the Whisper peaks at 3400 watts while the Jake peaks at 4000. The Whisper has a PM alternator, while the Jake has a wire wound field generator. The Jacobs puts out more power than the Whisper and it does it with 10% less swept area!*

*It is true that the Jacobs with the wire wound field is parasitic, that is, it uses some of its own power. But the power it consumes is marginal. At full output, the field draw is 6% of the output. However, it also means that the Jacobs is really producing almost 4300 watts at the generator, even though the batteries only see 4000 watts. This makes the power output of the blades as a function of their swept area even more impressive.*

*Far from gobbling, a 6% parasitic draw is not an undue burden on a system when all things are considered. In addition, wire wound field generators consistently out perform PM alternators in low wind speeds, where the wind generators spend most of their lives. For my money, I'll take the wire wound field generator any day. The machine 38 feet from my house is a Jacobs. Please note that I did not always hold this view. I spent ten years monkeying around with all manner of wind generators before I came to that conclusion. The bottom line reason why wind generator manufacturers use permanent magnets is because they are very inexpensive when compared to the materials and labor involved in building wire wound field generators. In today's marketplace, money and not necessarily performance is the driver.*

*You are right about airfoils stalling in low wind speeds. This is one way of controlling power output to a wind generator. Increase a blade's angle of attack enough and it will stall. This is how a blade activated governor works. However, you can stall a blade at high speed as well. As wind speed increases, so will the speed of the blades passing through air. However, blades cannot continue increasing their speed forever. At some point, increasing air speed becomes turbulent as it passes over the airfoil, and the performance of the airfoil declines accordingly. The blade "stalls", similar to the way it does in low wind speeds. You can overcome this stall by continuously fine tuning the pitch of the blade as wind speed increases. While it is true that this is what is done on utility scale wind farm machines, continuously pitching blades is far too complex and costly to include in residential-sized wind generators.*

*I agree with your discussion about 3-phase ac vs. DC. However, from a design standpoint, each phase in a 3-phase ac wind generator is responsible for only 1/3 of the current production. There is less heat built up in the wind generator because IR squared losses in the windings are smaller. Heat is wasted electricity. The machine can be said to be "more efficient". In transporting 3-phase ac vs. DC in a wire run down the tower and to your house, a 3-phase ac wire run is invariably cheaper than a DC wire run carrying the same amount of power.*

*Keep reading and writing, High. I enjoy the dialogue. And, please, get those towers up higher into the air. You'll be pleasantly surprised with the results. Mick Sagrillo, Lake Michigan Wind & Sun, Ltd.*

#### **RE Project DownUnder**

I thought you would be interested to hear of an Australian alternative energy project that I visited which seems to have great potential.

My description of the Project has relied heavily on a publication *Renewable Energy in Action: A Case Study* by Peter Zwack, Brunswick Electricity Supply.

In essence the Project consists of a combined wind and solar electricity generating facility which is located in an urban area and supplies power to the urban grid. It has been set-up in such a way that residents can add to its capacity through the purchase of PV panels. Participating residents are then credited by reductions in their electric bill. Buy-back rates above domestic tariff are even being seriously considered to act as stimulus to renewable energy.

Brunswick Electricity Supply Department (BESD) distributes electricity to the City of Brunswick which is an urban municipality within the City of Melbourne (Australia's second largest city—population about 2 million). Brunswick is a small municipality about 4 km by 2.5 km. Its customer base is 18,000 domestic, 1,800 commercial and 500 industrial. Load is around 30 MW—45% domestic, 30% commercial, and 25% industrial.

Project Aurora is the name given to a Grid Interactive Renewable Energy System (GIREs) installed in Brunswick. The funding for the system came via a Local Government Development Grant from the Federal Government.

The system consists of a Bergey/Westwind 10 kW wind turbine and 48 BP Solar 75 W PV panels feeding 96 volts into a 12 kVa Butler Solar/Siemens grid-synchronous inverter (415 v, 3 phase, 50 hz ac sinusoidal).

The project was originally scaled in size to approximately meet the energy needs of an adjacent community organization known as CERES (Centre for Education and Research into Environmental Strategies) where environmental education programs are run for students of all ages, teachers and the public. 20,000 students participated in 1991/92. The energy programs utilize a Low Energy house and Energy Park with energy/environmental displays. Brunswick Electricity has had a close relationship with CERES for the 10 plus years of its existence.

Project Aurora provides power for CERES, with excess going to other users on the grid. Spare inverter capacity is being utilized by expanding the PV array. This is the point where the public are invited to participate through purchasing a PV panel or panels and adding to the generating capacity of the system.

Rather than being a centralized wind farm or PV array, this project is more human scaled and capable of being comprehended by its owner (the public). The generators are owned by the people rather than a monolithic government or private organization. It is also located at the point of use, not "somewhere out there" away from peoples sights and minds.

At the time of my visit, BESD was seriously considering buy-back rates above domestic tariff to act as a stimulus to renewable energy. However, there is a further justification of such a favorable price differential. While residential load profiles tend to occur outside the insolation period, the overall peak demand occurs during the insolation period. Additional capacity that can be supplied during peak loads is

traditionally costed at a premium rate reflecting the increased costs of supplying peak as opposed to base load power.

This Project is innovative and exciting. The initiative shown by this Municipal organization is especially heartening. Jonathan Sutton, Bulga Rd., Bobin NSW 2429, Australia

*Alright! Thanks, Jonathan for another grid-connected success story. We hope the community gets behind the purchasing of modules for Project Aurora. The Home Power Crew*

#### Even a Four Year Old...

We've grown since the last time our subscription expired & we were looking for ways to "air-condition" our future home! Well, building has started & we've harnessed the winds from our hillside perch to not only flow through the house for cooling but we have plenty for our Whisper 1000 which powers our 35 foot RV (our temporary house during construction). Once inside our house we plan to trade up our 1000 for a 3000.

Your magazine & my husbands determination is making our dreams turn to reality. Our four year old is learning valuable lessons—she now looks outside to see how windy it is before requesting to watch Disney tapes or to play her games on our computer. Mrs. Shipman, Fredericksburg, TX

*The thing that strikes us the most about your letter is that your daughter is learning lessons that most of us weren't exposed to until well into adulthood! First, that our energy doesn't just magically appear out of the wall socket but has to be produced by some certain means. Second, that renewable energy is alive and well and works! We'd like to hear more about how you are using the winds to cool your home. Michael Welch for the Home Power Crew*

#### Buck Regulator

Just a note to let you know that the "buck regulator on a chip" (Home Power #37 & 38) is available in the 12 Volt form: LM2575T-12P+ from: Electronics Goldmine, PO Box 5408, Scottsdale, AZ 85261, 602-451-7454, fax 602-451-9495. The leads are quite short (about 1/4") on these new surplus units. The order number is G6953. Price: 3/\$1.25 or 100/\$39.00. How about that? Michael K. Tandy, Berkeley, CA

#### Parts

I love your magazine. Issue #47 was the best yet. Lots on wind power.

Have found a source of parts which might be of interest to the Go Power types. Surplus Center, 1015 W "O" St, PO Box 82209, Lincoln, NE 68501-2209, 402-474-4055—lots of stuff, new and used—DC motors, generators, hydraulics, differentials, gear boxes, master cylinder reservoirs, auto alternators, battery chargers, transformers, relays, etc., etc.

What do you think about tracking solar hot water panels? What would the expected gain be? Estimated output? I don't think it would be that complicated but would the increase, expense, & complexity be offset by the increased input? Possibly use it for home heating in winter? Curtis Potter, Hobbs, MN

*Hi Curtis. The full efficiency of any solar collector can only be taken advantage of by aiming it directly at the sun. That said,*

*it is not as important to go through the expense of tracking a solar water heater as it is to make sure that photovoltaic modules are pointed in the sun's direction. The main reason? Cost per amount of energy obtained. With PV, it is often cheaper to add a tracker than it is to buy enough extra modules to make up for not tracking. With solar H<sub>2</sub>O it is usually cheaper to add additional stationary panels. There are significant obstacles to overcome in tracking solar water panels. The two that immediately come to mind are the added weight of the panels and the water they hold, and the need to couple moving panels to stationary plumbing.*  
Michael Welch

### **Battery Recycling**

I wanted to write to say how much I enjoyed issue #48. The article on the lead recycling industry was especially interesting. I'm a user of lead-acid batteries myself and, as you know, I'm concerned about safety issues. It seems to me that responsible recycling is one of the key issues for the renewable energy industry.

As I read over Mr. McCrea's article the following thoughts came to mind:

1. It seemed a bit short and sketchy.
2. The issue of who sponsored the Carnegie-Mellon study is not of great importance. Most people would assume that industries would support issues favorable to their economic interest. The folks at Carnegie-Mellon might claim that Mr. McCrea, Hackleman, and Kennedy were biased in favor of their own interests. It seems to me that the larger concerns of long term safety are more important than taking one side or the other.
3. The emissions data in the article were interesting but also confusing. Was the test of June 1990 typical of the long term emission picture? How many batteries were melted on that day?
4. The article says that the "air leaving the smelter is as clean or cleaner than the air entering the furnace" yet it contains 3500 Lbs. of lead per year. Does the ambient air really contain that much lead? It sounds like a lot to me and I'm not sure I would want my kids down wind from that.
5. Is this the only lead recycling plant in the U.S.?
6. What is the overall track record of the lead recycling industry world wide?
7. Would it be possible to recycle the sulphuric acid too?
8. Are the plastic cases burned to fuel the lead smelter?
9. What are the present dimensions of the lead toxicity problem—local, national, and world wide?
10. What are the economics of lead-acid battery recycling?
11. If we put our best high paid rocket scientists, or better yet, our most ingenious Home Power brains to work on the problem—How low could we get total lead smelter emissions and what would it cost?

It is my thought that Home Power could help industry and consumers alike by giving us all an even handed and in-depth look at this issue. Information could bring awareness and then become a catalyst for global change.

Thanks for your great magazine! Jack Mills, Ben Lomand, CA

*Thanks for your comments and questions, Jack. We don't have all the answers, but it did appear that the study was*

*very one-sided. We found an article in The Battery Man (a battery industry trade journal) that talks about a brand new battery recycling plant in Columbus, Georgia. The plant is owned by GNB and can recycle 30,000 batteries per day. The company claims that absolutely NO hazardous waste or sulphur emissions will be produced. The plant even recycles the battery acid into sodium sulphate, a marketable product. All the plastic casings and lead are recycled into new batteries and marketable lead and plastics. Processing water is continuously reused. Even the slag from the furnace is reprocessed to get out as much of the lead as possible. Less than 1% of the slag's lead is left, which means that it is not hazardous waste, but can be disposed of in an ordinary landfill. The article did not mention how much lead was released out of the furnace smokestacks.*  
Michael Welch

*You ask many perceptive and essential questions, Jack. Unfortunately, we have answers to only a few at best. We need more info on lead and battery recycling and we are chasing it now. How about some help from readers who are actively involved in the battery scene? It is my personal understanding that the lead-acid battery is easily recyclable. Recycling could be environmentally benign if the recyclers take care and spend money on pollution controls. I recently read a report on battery recycling from Greenpeace. It indicated that much of the recycling is being carried on in developing nations (such as Mexico). Here the pollution controls are less than inside USA and the recycling process is cheaper. So from an environmental standpoint, where the battery is recycled is very important. We will continue to gather information and hopefully, Jack, we will have some answers soon.*  
Richard Perez

### **Perspectives**

I agree with you. The article describing how a PV system was negotiated and built on Ms. Risa Buck's property is not only different, but is one of the best I read so far on the subject ( I have every *H.P.* number with the exception of #1). I don't think her system is unique, but, as you pointed out, the fact that people with such different backgrounds contributed information is the most enlightening part.

Based on this experience, can *H.P.* add some items to the list that make up the reviews of "Things that Work" series?. One could be related with the safety registration of the product, i.e., UL, CSA (home or commercial), the other with the easiness of installation. We want and need the expansion of the renewable industry, but the manufacturers of components should strive to meet standards that are accepted practice in the home building industry.

It is not encouraging to hear Mr. Jerome Cordeiro ( the installer) complain about not having "at least two 7/8" knock outs for standard 1/2" flex fittings" in the PV panel box, charge controllers lacking a "wiring area large enough to connect conduit" or having to manufacture a custom made junction box for the inverter, because "I could not buy (a standard) one". Hector L. Gasquet, El Paso, TX

*Hi Hector. Thanks for your comments on Risa Buck's system article. We, too, were particularly taken by that project. Some of the equipment we test has the UL or other testing organizations' seals of approval. The Trace 4024, Statpower*



battery charger, the Heliotrope charge control, and the Ananda Power Center come to mind. We did mention these ratings in the *Things that Work!* articles.

Most approved safety-related equipment goes through testing programs that far exceeds the type of testing we can do here at *Home Power*. With the advent of electrical inspections, financing and insuring of RE systems, lab approval of all components is essential. I am anxious that *Home Power* readers understand what UL or ETL approval is and what it isn't. UL approval essentially means that the device is not a fire hazard. These labs do not test for many parameters that concern system designers and users. For example, UL does not test inverters for Total Harmonic Distortion (THD) or peak and RMS voltage regulation. UL rating is a good starting place for equipment choice, but the user needs to look deeper into the function of the component. This is why we do *Things that Work!* testing. Richard Perez

### Political Enlightenment

I write in reference to picture (issue 48, pg. 56) of a Vietnamese police officer checking "papers (label) on the Mekong River. The caption reads "...you don't have to be afloat in Vietnam to read it."

I spent most of 1969 & 1970 afloat in the waters of Vietnam with the US Coast Guard. My first reaction to the picture was not good: Homeless Veterans, women & children die daily from malnutrition related diseases here in Amerika while effort is made to get Vietnam on a version of the Rural Electrification Project?!?!?

Meditation makes me realize ANY good deeds are valid.

Same issue—same issue: I read you are "old hippies". Thanks for trying to stop the war. Kent State was my political enlightening—there was a war & I was on the wrong side!

I've been off grid over 20 years and a reader since issue #1.

Thank you (& others) for helping me see the light (*H.P.* pun intended) on several occasions in my life. Hope this helps balance any negative mail you might get about the picture. Dusty, Sprague River, OR

*Thanks for the support, Dusty. Actually the photo got very little negative mail. I think folks have decided that it is time for that old wound to heal. RE systems like the ones done by Marlene Brown and the Solar Electric Light Fund (SELF) are one way of healing these old wounds. By the way, the project was privately funded and no USA govt. funding was used. The SELF projects are primarily financed in country. Richard Perez*

### It Works!

I like your holistic approach—little touches like the subscription form cum envelope and not sending out renewal notices to tell people what they can read. Maynard Miller, Jetstream Power, Holmesville, OH

### It Works Again!

I love your magazine and I treasure every issue. I enjoyed meeting the entire staff at the MREA Fair. I just want to comment about the way you handle renewals. It is simply the best method I have ever seen!!! If people miss any issues, it

is their own fault. Renewal notices are just a terrible waste of time and resources. Keep up the good work! Michael Bera, Waukesha, WI

*Thanks Maynard and Michael. We just wish folks would pay close attention to their mailing labels so that they NEVER miss an issue. The Home Power Crew*

### Survey says...

Just wanted to let you know that I do read my mailing label, along with the rest of the magazine. I think it's very good and very educational. I have not filled out the survey, though, as my wife and I do not own our own house, although we hope to buy one within the next year or two. Once we have the freedom to do what we want, I plan on working toward a PV electric system, most likely grid-intertied. The PV patio cover from your "Solar in the City" article in HP#45 seems to be an interesting plan to try. Thanks for a great magazine. Chris Bergeron, Houma, LA

*Thanks Chris, but if you take another look at the survey, you'll see that we also want to know about what folks are hoping to do in the future. It's OK, you can always fill the survey out again once you get your system going. We use this survey information to find out what you are interested in reading. The Home Power Crew*

### Steam'in

Almost all of the electricity people use is produced by water, some by the pressure of falling water, but most by the pressure of heated water. Various energy sources may be used to heat water to make steam, more of the "popular" fuels are coal, oil, and nuclear.

Personally, I'm a photovoltaic advocate. Solar energy is simple, quiet, clean, reasonably efficient, reliable, affordable, and available to almost everyone.

Though I rely on photovoltaics for most of my electricity I also play with water—at the moment waterwheels—but many years ago built a wood-fired steam generator, and reading some questions raised in last issue's *Letters To Home Power* regarding steam power, thought I'd respond.

Almost anything can be dangerous if handled carelessly or with disregard for, or lack of knowledge. A careful person who builds his/her own power system takes every precaution to include as many safeguards as possible—yes even to the point of redundancy—peace of mind regardless of added expense.

For anyone who enjoys tinkering with mechanical things, who is contemplating building a steam generator, I would encourage them to do it. For all the aforementioned that photovoltaics has going for it, it lacks something that steam has: thrilling excitement.

However, I don't believe that steam power is very practical for home power generation. For one thing it requires an operator; it's not something you just set-up and let run itself. I suppose it's possible to build a lot of automatic controls but then there is the issue of fuel. Wood, even pelleted wood systems with automatic damper and flue controls, is not that consistent a fuel. As we *Home Power* readers know, those

other popular fuels are also objectionable; coal stinks, oil gets on your clothes, and fissionable material is difficult to obtain and all the regulations are a hassle to deal with. Home-brewed alcohol or hydrogen might be a possibility but then one might just as well burn them in an engine-driven-generator, or for that matter run an engine-driven generator on wood-smoke.

Why burn anything at all? The sun—that big beautiful blazing ball of burning hydrogen is already doing it for us. How about a Fresnel solar-tracking steam generator? Now we're talking. That's something a twentieth century guy can get behind. If anyone has any ideas along those lines I'd be interested in hearing about them,. In the meantime I'll be playing in the river with my waterwheel.  
Mike Mechanic, Tuolumne, CA

#### Usenet

I believe *Home Power* is what I had been looking for for years, as I love this topic. I only learned of *HP* from reading a comment about it in *Solar Today*... Then I found alt.alternative.energy on the usenet and found you mentioned there often. The sample issue you sent was everything I hoped it would be. The Steinburner's, Aptos, CA

*Hey, glad you caught us on the Net. I guess this would be a good time to sneak in an announcement about our upcoming world-wide-web page. We've been working hard on it, and hope it becomes a useful tool for all who are connected to the Internet. Look in our next issue for an address announcement. Michael Welch*

#### By Accident

I saw your magazine by accident at the local Barnes & Noble. Wow—where have you been when I needed you! I have a small PV system that powers my ham radio station and a few compact fluorescents. I've enjoyed experimenting with it and it's a fun way to teach the kids about renewable energy. Would you be interested in an article about my system—how I sized it, what I've learned, etc.?  
Dave Casler, KE0OG, A@prodigy.com, Louisville, CO

*Hi Dave, We'd love to see an article about your small system. That's how we all learn and grow. And we trade a two year subscription for any article we print, too.*  
Karen



SUNFROST  
camera ready  
on negative  
b&w  
4.4 wide  
3.4 high

## WE WROTE THE BOOK ON ELECTRIC CAR CONVERSIONS

**CONVERT IT** How-To Manual  
by Michael Brown with Shari Prange

Expanded & Updated 3rd Edition  
\$30.00 tax & postage included

"We built Mr. Brown's car,  
and we won." Bruce Burk,  
St. Johnsbury Academy,  
1991 American Tour de Sol  
Open Class Winner.



**ELECTRO AUTOMOTIVE**  
**POB 1113-HP, FELTON, CA 95018**

### READ YOUR MAILING LABEL

We don't send out renewal notices for your Home Power Sub. The last issue of your Home Power Sub is printed on your mailing label.

Check it out and don't miss an issue!

# Q&A

## How Tough Are PVs?

Dear *HP* Crew, an excellent publication. Much attention is paid to the electrical aspects of solar electric panels. I wonder if you could "Ask NREL" to elaborate on the physical and structural aspects of solar electric panels: i.e. Please describe the hail impact test and wind loading test. Obviously solar panels are designed to be out in the elements, but what are their physical limitations. I am in the habit of bringing my two J48's indoors when severe weather threatens. With no back-up or insurance, I tend to sleep better knowing that my only source of power is not being subjected to high winds and large hail. Would this be an over reaction? Obviously those of us with large arrays could not do as I do, however, I do feel that this subject needs some attention!

Thank you very much. Ray Watkoski, PO Box 104582, Jefferson City, MO 65110-4582

*Hi, Ray. I know that NREL and the Jet Propulsion Labs (JPL) test the physical strength of PV modules, I'll work on an article for this in the future. For right now, I can answer some of your questions from personal experience. Hailstones larger than golf balls have fallen twice here in the least eight years. The last hailstorm was in July 1992 and completely denuded the oak trees in our neighborhood. The ground was covered with hailstones to a depth of two inches. All the PVs in the neighborhood (must be over 100 modules round here) survived, not one was cracked or broken. Our modules yearly see winds in the 40 to 80 mph range. If the PVs are firmly mounted, wind presents no danger. The only physical failures we have seen are due to vandalism or poor PV mounting. One system in this neighborhood had the modules mounted on the roof of a metal garden shed. Unfortunately the garden shed was not secured to the ground and it blew over and rolled downhill. The modules were wrecked—broken glass and split intercell wiring.*

*If your modules are firmly affixed to a good rack which in turn is firmly mounted to the ground, then you have no worries from Mama Nature short of a tornado. Many, many more PVs are destroyed by being gun shot by idiots than are destroyed by hail or wind. How about HP readers, got some tales about what kind of weather your PVs have survived. While lab testing is fine, it isn't real life. Richard Perez*

## Different Position, Different Voltage

Two years ago I installed a set of Bronze ARCO QuadLams at a friend's remote cabin. I used two 6 Volt 'golf cart' batteries and a Sun Selector M-8 charge controller. Panel voltage under load was 16.9 Volts. The system worked flawlessly until this winter when a tree fell and broke one of the panels. My friend told me that the system continued to function for three months until a couple of weeks ago when the battery voltage began to fall. Since the broken panel had been exposed to a couple of rainstorms (and because the insurance company was footing the bill) we decided to replace the broken panel with a new one. A Bronze was no longer available, so we bought a Gold from a different dealer. Upon arriving at the cabin, I found that my friend had opened the main disconnect switch, the battery voltage was at about 11 Volts, and no lights would function (with the switch now closed). I also found that when the tree fell it pulled loose one of the series connection wires between the broken panel and another panel. I repaired the wire and then discovered that the battery connections were loose. Upon tightening them, the lights worked. The next day, I replaced the broken panel with the new Gold panel, and was surprised to find that at noon, under load, the panel voltage was only about 13.3 Volts. Current was about 5.5 Amps. I then tested each panel individually under load and found that the outputs were the following: Panel 1 in the array: 4.1 Volts, Panel 2: 3.7 Volts, Panel 3 (Gold): 5.1 Volts, Panel 4: .03 Volts. (By the way, Panel 1 is the one whose positive terminal is connected to the charge controller). After further inconclusive troubleshooting, on a whim I switched the position of panels 4 and 1 (Gold). Now the voltages were: Panel 1: 3.6 Volts, Panel 2: 2.2 Volts, Panel 3: 3.3 Volts, Panel 4 (Gold): 4.4 Volts. Total voltage was still about 13.3 Volts. Open circuit voltage was about 25. I made a quick check of all the panel to panel wiring (the "pull:" test) and all seemed OK. Also, I briefly removed the charge controller from the circuit and the voltage remained at 13.3. So, two questions: 1) Why does the position of the panels in the array affect their output, and 2) Why is the system putting out only 13.3 Volts? FYI—the temperature was about 90°F, and the batteries had been "overfilled" (is this possible?) by my friend three weeks earlier. I removed enough water so that the plates were just covered. Thanks for your help. Matt Danning, Berkeley, CA

*Hello, Matt. The answer to question #1 must be funky wiring and/or bad connection(s). Considering the condition of the rest of the wiring, I'm sure this is the case. In a series string of PV modules, it will not matter which order the PVs are connected. It is a series circuit and the current will be limited by the weakest module.*

The answer to question #2 is that the PV array's voltage will always be just slightly higher than the battery's voltage. PVs are essentially constant current devices. The voltage of the array will immediately fall to battery voltage (plus wiring and control losses) the instant the array is connected to the battery. The current, voltage under load, and open circuit voltage measurements you give are all within spec for a working Quadlam array. Check out the Current vs. Voltage curves for PVs in this issue (pages 28–33).

I hope you saved the water you removed from your friend's batteries. Actually it wasn't water, but a solution of sulfuric acid in water. When your friend overfilled the cells, he diluted the electrolyte. The best way to deal with overfilling is just let the battery alone. Eventually hydrolysis will remove the added water from the cells and the electrolyte will return to the proper concentration (1.260 specific gravity). Get a hydrometer and measure the specific gravity of your friend's cells. Do this when the cells are fully recharged. If the specific gravity is below 1.22, then add some electrolyte (you can get 1.260 specific gravity sulfuric acid solution from any battery shop) instead of water next time the cell needs watering. This will restore the electrolyte to the proper concentration. Richard Perez

### Protection

I have a log cabin that is located too far away from the grid. I have been broken into and vandalized a couple of times. I would like to know if there is a security system that would sound an alarm and scare away would be intruders and send a signal via the air waves to my nearest neighbor who is 1000 feet away. I have been your fan since issue #1. Phillip Carroll, Rutland, VT

Hi, Phillip. Just about every home alarm system can be independently powered by a 12 Volt battery and a small PV module. Most alarms will close a relay when the alarm is triggered. This relay can be wired to activate a 12 VDC alarm (buzzer, horn, or other noise maker), turn on some lights, or in your case activate a radio transmitter. Consider buying two small 49 MHz walkie talkies. Install one at your neighbors home and the other at your cabin. Most of these inexpensive (under \$50) walkie talkies have an alert tone for calling or for sending Morse code. Simply wire the transmitter at your cabin so that it broadcasts this tone when the alarm is activated. This is easily accomplished by setting the transmitter permanently on in tone mode and connecting the power source for the transmitter through the alarm's relay. Radio Shack can sell you all the parts needed to accomplish this for under \$100. Hooking it up takes a little savvy, so get some help if you are not familiar with electronics. I am sure that there are commercially available alarms with radio links built-in. I am also sure that they cost much more than the solution suggested here. If you are not comfortable with the homebrew solution, check out the local alarm companies in your neighborhood. This job should be duck soup for them. Richard Perez



## Helio-Gram

October/November 1995

### PWM CHARGE CONTROLLERS ARE BECOMING MORE POPULAR.

Twelve years ago Heliotrope General pioneered this concept with the introduction of the CC-10 PV charge regulator. Prior to this time all PV chargers were simple on/off regulators. The problem with an on/off regulator is when the desired regulated voltage is approached. At this point charging is turned off and thereafter you get a lower battery voltage reading.

PWM (Pulse Width Modulation) strategy takes over when the battery has reached the point of voltage where other chargers turn off. PWM slows down the "filling of the battery" (like topping off a gas tank) as it approaches its maximum charge potential. This slowing down of the charge rate has the desirable effect of greatly reducing the water used by the battery plus bringing the battery to a higher State Of Charge (S.O.C.) faster.

PWM by itself is a misnomer for our charge controllers. Actually the charging sequence is a "Series " of three distinctly different stages. The first stage is the bulk charge where all available module power goes to the battery. The second is the PWM stage where the battery is more slowly charged to top it off exactly at the selected S.O.C. The final stage is a trickle charge to maintain the S.O.C.

Prices of these superior PWM controllers has always been and will always be higher than on/off regulators. Just look at the circuit board of the two types and you can see the difference in the quantity and types of components required to perform the more sophisticated control.

Although the cost for a PWM controller is frequently twice or more, this cost difference is justified. In terms of total systems cost, a PWM charger adds less than 5% to the total bill. The results from this expenditure represents an excellent investment in overall system performance...S.O.C. is always higher, less water is used, and battery life is lengthened.

Components that handle the power in Heliotrope General controllers are overrated. Users do not need to derate our specified current ratings.

Call us at 800/552-8838 and receive our brand new full color consumer leaflet for the SOLPAN™ Power Center. SOLPAN™ is listed by ETL to UL 1741.

Our products are available through leading AE Distributors and Dealers worldwide.

*The name means reliability.*

Heliotrope General  
3733 Kenora Dr.  
Spring Valley, CA  
91977  
Fax (619) 460-9211  
(800) 552-8838  
(619) 460-3930





## Home Power MicroAds



Rates: 10¢ per CHARACTER, include spaces & punctuation.  
\$15 minimum per insertion. Please send check with ad. Your cancelled check is your receipt.

USED WIND GENERATORS, Towers, inverters, & Water Pumpers: 80 systems in stock, 1500 Watts to 10kW. We repair & make replacement parts, blades & governors for most wind systems, pre-REA to present models, specializing in old Jacobs wind generators. We build tilt-up towers and tower-top adaptors for the Whisper Wind Generators. Best prices on Bergey, NEO, Whisper, & Windseeker. Plus we pay shipping to the lower 48. Call with your needs or write to Lake Michigan Wind & Sun, 3971 E Bluebird Rd, Forestville, WI 54213, 414-837-2267, Fax 414-837-7523

DWELLING PORTABLY in tents, domes, vans, trailers, wickiups, remote cabins, unfinished houses, etc. What works and what doesn't. \$1/issue. POB 190-hp, Philomath OR 97370

PURE CASTILE & VEGETARIAN SOAPS. Handmade in an AE environment. We also have hard to find natural bath & body care products. FREE catalog: SIMMONS HANDCRAFTS 42295 AE, Hwy 36, Bridgeville, CA 95526

HYDROELECTRIC SYSTEMS: Pelton and Crossflow designs, either complete turbines or complete systems. Assistance in site evaluation and equipment selection. Sizes from 100 watts to 5 megawatts. Manufacturing home and commercial size turbines since 1976. Send for a free brochure. Canyon Industries Inc., P.O. Box 574 HP, Deming, WA 98244, 206-592-5552.

LOW WATTAGE KIRBYS (110 VAC) Rebuilt with 6 mth guarantee. In HP#23 Home & Heart.& HP#32 Things That Work. 3 Amp/\$175 4 Amp/\$150, tools/\$25 UPS/\$25. SANDERSON'S 20295 Panoche Rd., Pacines, CA 95043 or (408) 628-3362

XXXXXXXXXX USED SOLAR MODULES XXXXXXXXXXXXX  
XXXXXXXXXXXXXXXX 16-2000 - \$165.00 XXXXXXXXXXXXXXXX  
XXXXXXXXXXXX ARCO M51 — \$185 XXXXXXXXXXXXXXXX  
2000+ Amp Hour phone batteries, cheaper than golf cart batteries — \$175 per cell. Cruising Equipment new E-Meter \$179. Trace inverter 2512 \$1095. 1000 watt sine wave inverter 48V \$200, new 14 cu ft gas refrigerator \$1795, new & used ni-cads from AAA to 250 AH. Will match or beat anyone's prices on equipment. Call or write for free flyer. Craig, 10192 Choiceana, Hesperia CA 92345, 619-949-0505. Trade-in's welcome. M/C VISA Discover accepted

AVAILABLE NOW FROM THE MIDWEST RENEWABLE ENERGY ASSOCIATION: Renewable Energy/Efficiency Directory. A great networking tool listing users, providers, networkers, educators and "do-it-yourselfers" in the RE fields. Send \$5.00 (includes postage and handling) to: MREA, POB 249, Amherst, WI 54406.

VERMONT SOLAR ENGINEERING — Expert design & consultation, professional installation, sales & support, repair & upgrades — PV, Hydro, Wind & Domestic Hot Water. Do-It-Yourselfers welcome—pricelist available (sorry, no catalog). Custom systems, kits & components at most attractive prices. Call Kirk toll-free, 1-800-286-1252, 802-863-1202(local), 863-7908(fax). 69 Thibault Pkwy, Burlington, VT 05401. WE USE WHAT WE SELL. Serving the Northeast since 1991.

CEILING FANS: The largest selection of DC Powered (12 & 24VDC) ceiling fans anywhere in the U.S. From traditional to modern, classical to custom design. For brochure and list of dealers send SASE to R.C.H., 2173 Rocky Crk Rd, Colville, WA 99114. Dealer inquiries welcome FAX 509-684-3973

START YOUR OWN TECHNICAL VENTURE! Don Lancaster's newly updated INCREDIBLE SECRET MONEY MACHINE II tells how. We now have autographed copies of the Guru's underground classic for \$18.50, Synergetics Press, Box 809-HP, Thatcher, AZ 85552. (520) 428-4073, VISA/MC.

INTERESTED IN INTENTIONAL COMMUNITY? Communities magazine offers complete, updated listings of intentional communities not found in the Communities Directory. Practical information about forming/joining community — alternative buildings & structures; getting off the grid;# legal, financial & land options. Plus Eco-villages, Cohousing, decision-making, conflict resolution, successful communities, children in community, research findings on community living. Quarterly. \$18/yr, \$5/sample. Rt. 1. Box 169-HP, Louisa, VA 23093. (703) 894-5126.

WIND/SOLAR/HYDRO ELECTRIC SYSTEMS. New & Used Equipment, Energy saving equipment. Propane Refrigerators, Lights, Heaters. Charge Controllers, Mounts, Trackers, Meters, Battery chargers, Fuses, Best buys on SunFrost refrigerators, DC & AC Lights, Inverters (up to 35% off), Circuit breakers, Pumps, Low cost DC motors, Hydraulic Ram pumps, Fans, Evaporative coolers, Grain mills, Bed warmers, Tankless instant water heaters, Composting toilets, Low flush toilets, Fence chargers, Pocket tools, Solar cookers, Solar stills, Books, Shortwave radios, Food. See large ad. General Catalog \$4. We also have a Windmill Water Pumper/Hand pump Catalog for \$5. DC powered garden tractors info packet for \$6, KANSAS WIND POWER, Dept. HP49, 13569 214th Road, Holton, KS 66436, 913-364-4407 Discount Prices! Since 1975.

EARTH-SHELTERED HOMES This definitive manual by noted authority Loren Impson features detailed building instructions for the amazingly affordable and practical Ferro-Cement Dome Home. Only \$15 from Sun Life P.O.Box 453, Hot Springs AR 71902

OPERATOR AND SERVICE MANUALS: Servel Gas Refrigerators "all models", \$10; Jacobs Windplants \$9; Wincharger Windplants (32V/110V) \$7; Books: Wind and Windspinners "\$7" and The Homebuilt Wind-Generated Electricity Handbook, "\$9", Both by Michael Hackleman. Book rate incl; add \$3 for 1st class mail. Or send SASE for pub list to: M. Hackleman PO Box 63, Ben Lomand, CA 95005

FOR SALE: 40 kw Enertech E44-40 induction wind generator system on 100' freestanding tower with controls for a three phase utility interconnect. This was a utility demonstration project, the project is over, and the system is available. The wind generator was completely overhauled less than two years ago. \$18,000 crated, f.o.b. Forestville, Wisconsin Lake Michigan Wind & Sun (414) 837-2267.

CONSTRUCTION PLANS AND ROTOR Magnet Kits Shipped Worldwide Since 1987. Don't let the experts rule your life — build your own brushless, low-revving power generator—from scratch! Let's be realistic, unless you own a slave, the only way to get a long-lasting generator for a windmill, water turbine or steam engine, with a decent output at low revs, without costing a small fortune, is to build it yourself. Contact Al Forbes, 16 Parker Rd., Oratia, Auckland, New Zealand—phone 64-9-8188967 anytime or fax 64-9-8188890 for a free brochure on the Homebuilt Dynamo.

NEW DEEP CYCLE Lead Acid Batteries manufactured by YUASA-GBC. The HUP is designed to be discharged to 80% of its capacity over 2100 times during the 7 year factory warranty. The U.S. Department of Energy rated the HUP #1 in its field. Today the HUP is the battery of choice for the Smithsonian Tropical Research Institute, being used in Renewable Energy. Free shipping 48 states. Call or write Northwest Energy Storage, 10418 Hwy 95 N, Sandpoint, ID 83864, (208) 263-6142.

**BUILD YOUR OWN FERRO-CEMENT WATER TANK.** Any size. Booklet tells all you need to know. \$12+\$2 P&H to Precious Mtn, 1221 Niestrath Rd, Cazadero CA 95421 Satisfaction Guaranteed New Edition

(ATTENTION) WE HAVE Wind Generators, the much in demand Air 303 plus the whole Windseeker line. We have the new Trace 4000 watt True Sinewave Inverter for \$2495 S&H included. We also have a Big selection of Solar Modules, all makes & sizes. Call Dan's Wind & Solar 520-337-2766

**LED ILLUMINATION:** Ultra High Efficiency Light Emitting Diodes provide 10 times the battery life of incandescents. Flashlight \$10.95 (includes batteries). LED arrays, 5 diode unit \$7.95, 10 diode unit \$11.95, 20 diode unit \$19.95. Larger arrays can be made on request. Red or yellow LEDs available. Units have essentially unlimited life. Free information. Noctilume, P.O. Box 7800, Fox Hills, CA 90233 (310) 967-4719

**SURPLUS, DEMO, AND USED Solar & home power products** at great prices! All items thoroughly tested. Call or write for free newsletter and current products list. 1-800-364-9941, Suntrek, 303-C Creek St. NE, Yelm, WA 98597.

**APROVECHO RESEARCH CENTER** offers 3 month training sessions in appropriate technology, sustainable forestry and organic gardening. Classes begin June, September, January (1 month in Mexico), March. Daily classes 8:30-5:30. Cost is \$500.00 per month, includes room, board. For more info: 80574 Hazelton Rd., Cottage Grove, OR 97424. (503)942-8198

**FINALLY, A COOKSTOVE THAT CAN HEAT** your home, cook a gourmet meal, and even help with the dishes. Rayburn wood and coal burning cookstoves are available in 10 porcelain enamel colors with optional 8K to 55K BTU boilers for heating tap water and/or hydronic heating. Send \$2 for information and color brochure to: Classic Cookers, RD#3 Box 180-705A, Montpelier, VT 05602. 802-223-3620.

**NEW ARCO M52 TRILAM BLEMS** 6.2 minimum Amps and 16.5 Volts \$230. Beat The Cold! Garden Bed 6x5 foot Aluminum Mini-Greenhouses with triple layer capability \$129.95. Information: ECO Designs 800-500-3216 or 916-265-2345

**A VARIETY OF SOLAR PANELS** Available, some used, some surplus; All Great Deals. Call (707) 972-2073 (California)

**STOP POISONING YOUR FAMILY,** pets, livestock, home and our fragile environment with the Harsh Chemical laden products you are using!!! YOU Now have the POWER to DO something about it! Start using these Natural, Earth Friendly, Biodegradable and Totally NonToxic products Today! We have an Exciting assortment of Personal care products with pure Tea Tree Oil, a natural antiseptic, pain reliever and healing agent. Skin care products to protect your skin naturally. Health & Nutrition products that provide You with the right nutritional tools for Your body. Concentrated Home Care products to take care of Your everyday cleaning tasks + more! These products really work! The products and their ingredients are Never tested on Earth's Precious Animals. We really enjoy these products and so will You! If we all do a little, together, we can do ALOT! Help us make a Big difference for our Fragile Planet! A portion of our Families profits as Independent Associates goes toward Renewable Energy Education! "Keep the Dream!!!" Distributors always welcome. Free catalogue & Distributor Info. The Silver & Bonnie Niewiadomski Family Homestead Farm, 102 River Drive, Plover, WI 54467, 715-344-0924

**CARRIZO SUPER GOLDS** Guaranteed at 105 W. Limited supply that helped powered the Midwest Renewable Energy Fair. Priced to go at \$4/Watt. \$420 (+ \$20 UPS East of Rockies or \$25 UPS West of Rockies). Lake Michigan Wind & Sun 414-837-2267.

**FOR SALE BERGEY 10 KW Wind Power Generator** complete with new control panel and complete 70 ft tilt-up tower — excellent condition Must Sell 314-271-5146

**3 RECONDITIONED JACOBS WIND Generators.** 2—2400 Watt 32 Volt for \$1500. each. 1—1800 Watt 32 Volt for \$1000. each. 1—Aeromotor Waterpumper 12 foot with 45 foot tower...\$1000. 2 Towers 80 foot..\$400. each or \$600 for both call 707-943-3848, mess. phone 707-943-3755

**ELECTRIC GARDEN TRACTORS (2)** Made by G.E., 42" cut front mount mower decks with electric lift, electric snowblower, newer nicd batteries, \$450 ea. (517)-686-0837.

**10% OFF CATALOGUE ITEMS** Wind/Solar electricity generating equipment. Water and air heaters. Catalogue \$4 Solar Creations 2189 ST. RT. 511A Perrysville, OH 44864 419-368-4252.

**VOYAGER UHF TELEPHONE SYSTEM.** Remote, base, 2 Yagi antennas. Reliably connects you to local TelCo up to 10 miles away. Low power demands. 12V or 120V. Full duplex digital operates FAX, modem, answering machine. \$4000 system sell for \$2500. Call (907-)747-4810 eve. or write MIV Box 6271, Sitka AK 99835 for more info.

**55 YEAR OLD NI-CDs,** 4" x 4" x 20" each. Metal cases, tapered posts, dry, need reconditioning. U-Haul=Free. Ron @ Madison,WI 608-829-3541

**1800 WATT JACOBS** \$950. with 50 ft tower \$1050. 7 sets wind generator blades from 8 to 14 ft. dia. Call for prices OH. 419-435-7087

**12 VDC FLUORESCENT BALLAST**—reliable & safe, instant start, no flicker or noise, use for 10–20W. Send \$8.00 to GSI, Dept A, 246 5th Ave, #512, NY, NY 10001

**WAREHOUSE CLEARANCE SALE.** NEW! Solarex and BP solar electric modules—As Low As \$4.50/W. Trace inverters, Morningstar and SCI regulators. Also, discontinued and used PV equipment. \$3.00 Catalog/Refundable. SWPV Systems, 212 E. Main St., Tomball TX 77375 (713) 351-0031

**GEODESIC DOME** 55ft diameter, (50ft base circle diameter), approx. 36ft high. Designed to withstand 130 knot winds, or ice load of 16 inches rime ice in combo with 87 knot winds, (Buckminster Fuller Patent). Disassembled, used, good condition. Fiberglass panels and galvanized steel base ring, (no bolts included). \$4000 + shipping. 717-530-8282 after 6 pm Eastern

**SUNWIZE ENERGY SYSTEMS, INC.** a Besicorp Company, in Kingston, New York, is expanding operations and is looking for an experienced Photovoltaic Sales Person and a Photovoltaic System Design Engineer. Salary commensurate with experience. Full benefit package. Please send resume to: L. DuBois, SunWize Energy Systems, 1151 Flatbush Rd., Kingston, NY 12401.

**TRACE 2524 2.5 KW INVERTER** w/cooling fan and cables \$850. Myson 325 LP on demand water heater \$300. Big Discount: 2000 Amps @ 250 VDC single pole, w/matching 2000 A. shunt and meter \$500 OBO. Paul @ 503-621-3028.

**REMOTE TELEPHONE LINE EXTENDER** System by Ritron. 2 lines, served us well, complete package \$1500 (916) 266-3302

**EDTA RESTORES SULFATED Batteries.** EDTA tetrasodium salt, info, catalog, \$12/lb plus \$3.50 ship & handle. Trailhead Supply 325 E. 1165 N. Orem, UT 84057

**FOR SALE INVERTER** Heart H-24-2500 SX. Needs up grade! Bought sine wave Trace \$300.00 firm 503-878-2480 Oregon

**ATEC FOR POWER.** Open or Closed system. Not solarcell, no fuel, no grid, no BULL!! Call Jon @ 907\*562-0391 need> \$10,000 to bring concept to reality. Trust me. Will start work on >50Kw gen-set make 50% payable to The Power Alternative POB 240565, Anchorage, AK 99524 Will COD for balance.

POTABLE WATER PROBLEMS? PV water disinfection system developed by U.S. Army. No chlorine to mix. Nothing needed but sunlight and salt. Disinfects up to 1500 gals. in one hour and consumes only 8AH @ 12VDC! \$4500 for basic portable system \$3.00 for catalog. SWPV Systems, 212 E. Main St., Tomball TX 77375 (713) 351-0031

WOOD-FIRED WATER HEATER: Perfect for remote areas 15 gal. Heavy-gauge steel. \$279 Free shipping until Dec 31 F. Rock Co. P.O.B. 92321 Austin TX 78709 512-406-4236

TWO TRACE 2248 INVERTERS with stacking interface and ACTC. \$1000. IBE 48 Volt battery charger \$500. Windseeker 500 12V \$400. 619-937-0307

5 KW "BEST" INVERTER 48 Volt D.C./ 120-240 volt a.c. has load search—\$900.00 Wattsun 8 panel tracker \$350.00 (503) 535-9819

KNOWLEDGE CARDS. Tables. Formulas. Fun and educational. Great gift. Package \$2. Box 12238 Lexington KY 40581-2238

HIGH TEMPERATURE SOLAR HEAT Generators: R&D data is needed for absorption cooling prototype. Research for senior project at CA State U. Please, send info: Angel 1112 N. San Pablo, Fresno, CA 93728. Thanks

OWN YOUR OWN PRIVATE LAKE with small hydro electric dam (Built in 1930s) has turbine and generators. 117 acres of wooded scenic land surrounding lake and river • see beaver, wolf, otter, etc. Wisconsin \$195,000 Will help finance or trade for ? 414-650-0246

"TEXAS RESIDENTS" Call Solar Utility Network in Waco, TX for Competitive pricing on R.E. equipment New and Used. Sell, Install and Service. (817) 799-4909 (800) 713-4909

FLOWLIGHT 24V BOOSTER Pump with Teel Precharged Water Tank. Used for only 3 years \$350 (707)839-1997

WANTED—COMPOSTING TOILET—gray water filter system—vacuum tube hot water solar collectors and a good used photovoltaic system. 414-650-0246

IT'S GETTIN' COLD AND THE DAYS are gettin' short. With Ni-Cds, you can take'em flat and they'll come back! And the Volts stay high when the temp's go low!. Used NiCds, 240 AH, 12 Volt, \$350.00, 5 sets. Other sizes available. Call 607-532-9517 After 6 PM Eastern

YOUR ALASKAN SOLAR EXPERTS! Complete source for Alaskan alternative power. ABS Alaskan, 2130 Van Horn Road. Fairbanks, AK 99701 907/452-2002, AK 800/478-7145

HELP SAVE THE FUTURE! Full time employment in PV/wind energy sales. Career oriented and experienced only. Send resume to SWPV Systems, 212 E. Main St., Tomball TX 77375 (713) 351-0031. Relocation Req. M/F

TRACE 2624 SB DVM 2600 Watt inverter/battery charger with all options. 24V. Orig. List \$1975. \$950 plus shipping. Jeff Fowler 413-238-5504

SUN-MAR COMPOSTING TOILET. Unused demo, non-electric model. \$700 707-839-4954

NEED A JOB? Get a good-paying job instead of a Dead End minimum wage slave job. Sell solar power generators on location. You buy from us or take orders; we ship to you or buyer. You are only limited by your time and efforts. This worthwhile job enables you to help the environment and earn as much money as you want. Distributorships are available for qualified individuals. We do not discriminate. We reward those who produce the most business for the company. Nationwide and international opportunities available. Call (805) 563-2687, Solar Systems LTD, 32 W. Anapamu St. #257, Santa Barbara, CA 93101

"REMOTE PHONE, OPTAPHONE +, complete system \$3500.00 Call for Details 707-987-2625

BATTERY BANK: Exide lead acid battery bank. 12V at 2000 AHR, or 24V at 1000 AHR. New old stock, dry, never used. Approximately 1/2 list price. Call (610) 274-3041 and leave message, or internet to 76754.317@compuserve.com.

FOR SALE: TRACE INVERTER: Model 2012, Exc. condition, \$600.00: Honda Generator: Model EM3500 SX, Elec. start, exc. condition \$1250.00: call 607-871-2452, Alfred, NY

SUNFROST RF-16 24 VDC 1 1/2 years old, white \$1500. Onan 6.5 KW 50 Amp/120V model NHE Propane fired, many new parts/starter & regulators. \$2000. Canterbury NH 603-783-9059

WINDGENERATOR 1800 W New, Never Flown Enertech—For use with utility Cost \$3,600 sell \$1,800 O.B.O. Call Joe 516-285-8899

INTENTIONAL COMMUNITY GOING Off-Grid wishes to purchase 2 used 17.5 KW or larger wind generators with 120 ft towers. Also need used PV panels and (numerous) deep-cycle, lead acid batteries or equivalent. In addition we will need the remaining components to complete the system. Also installing hydro, need 2000 ft of plastic or metal pipe. "Individuals Only, No Dealers Please." Michael 970-586-7171.

POWER ANYTIME! With the Solar Systems SS1000. Run electrical appliances with the light of the sun. Perfect for emergencies, power failures, camping, recreation, work at remote locations, onboard boats, and for powering lights, computers, printers, radios, TVs, VCRs, and telecommunications anywhere. The SS1000 comes complete with flexible, lightweight, (1.5 lb.) solar panel, 12 Volt battery, and 100 watt ac inverter. Can also be charged from 120 volt household outlet. \$475 plus \$22 shipping and handling. Calif. residents add 8.25% sales tax \$39.00. Call (805) 563-2687, Solar Systems LTD, 32 W. Anapamu St. #257, Santa Barbara, CA 93101

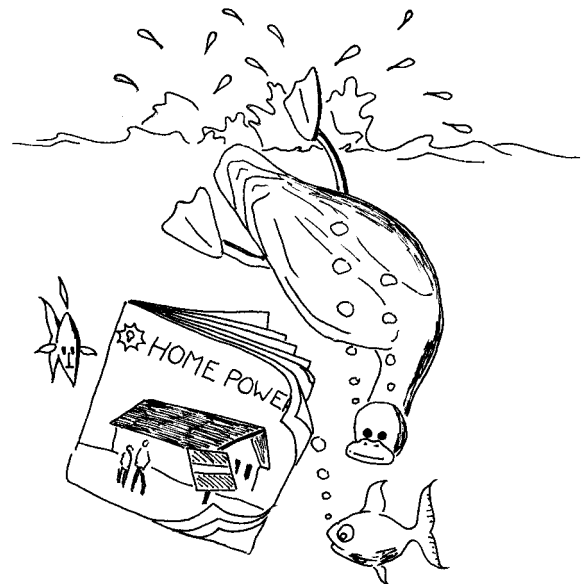

*Don't let your sub sink!*

We don't send out renewal notices — read your mailing label to see when your subscription ends.

## Index to Advertisers

- A.C.I. – 74  
Abraham Solar – 74  
Adopt a Library – 93  
Advanced Composting Systems – 79  
Alternative Energy Engineering – 47  
Alternative Transportation News Back Issues – 99  
American SunCo – 71  
Ananda Power Technologies – 21  
Aurora Power & Design – 67  
BackHome Magazine – 71  
Backwoods Solar Electric Systems – 57  
Bogart Engineering – 66  
Bubble Action Pumps – 66  
C. Crane Company – 99  
Carrizo Solar – 20  
China Farm Machinery – 88  
Communities Magazine – 91  
Cruising Equipment – 1  
Dankoff Solar Products – 79  
Electro Automotive – 106  
Electron Connection – IBC  
Energy Outfitters – 79  
Energy Systems & Design – 96  
Environmental Marketing – 74  
Environmental Solar Systems – 67  
EnviroTech – 78  
Exeltech – 57  
Fowler Solar Electric – 75  
Gimme Shelter – 91  
Go Solar – 78  
Go Solar Enterprises – 99  
Great Plains Power – 80  
GSE – 34  
Hackleman Videos – 60  
Harris Hydroelectric – 88  
Heart Interface – 1  
Heaven's Flame – 98  
Heliotrope General – 108  
Hitney Solar Products – 96  
Home Power Back Issues – 97  
Home Power Biz Page – 81  
Home Power CD-ROM – 39  
Home Power Sub Form – 80  
Horizon Industries – 85  
Hydrocap – 78  
Intelligen Energy Systems – 51  
Jack Rabbit Energy Systems – 60  
Jade Mountain – 88  
Jeff's Gas Appliances – 88  
KTA – 75  
Lake Michigan Wind & Sun – 35  
Lil Otto Hydroworks – 91  
Mainline Electric – 85  
Midway Labs – 85  
Mr. Solar – 90  
MREA Workshops – 97  
Naturlite – 88  
Northwest Energy Storage – 80  
Offline – 70  
Photocomm – 13 & 71  
PV Network News – 88  
Quick Start REading Special – 99  
Read your mailing label – 41  
S&H Alternate Energy – 42 & 71  
Sanderson's Rebuilt Vacuums – 98  
Siemens – 27  
Sierra Solar – 70  
Simmons Handcrafts – 80  
Sinking Sub? – 111  
Snorkel Stove Company – 67  
Solar Bright – 80  
Solar Chef – 98  
Solar Depot – 5  
Solar Electric Inc. – 35  
Solar Energy International – 61  
Solar Energy Resources – 90  
Solar Industry Journal – 91  
Solar Pathfinder – 75  
Solar Quest – 60  
Solar Systems Ltd. – 78 & 91  
Solar Village Institute – 56  
Solar Works – 87  
Solardyne – 39  
Solarex – BC  
Solarjack – 34  
Solartrope – 85  
SoloPower – 67  
Southwest PV Systems – 51  
Southwest Windpower – 12  
Staber – 75  
Statpower – 42  
Sun Frost – 106  
Sunelco – 35  
Sunline – 85  
SunSelector – 48  
Tommorrow's World – 60  
Trace Engineering – 33  
Trojan – 48  
United Solar Systems – IFC  
UtilityFree – 79  
Wattsun (Array Tech Inc.) – 26  
Wind & Sun – 61  
Windstream Power Systems – 67  
World Power Technologies – 80  
Zomeworks Corp. – 47





# No Power? No Problem!

From System Design to Installation...  
Renewable Energy systems for your home, RV, and lifestyle.  
**Electron Connection - Call Toll Free 1-800-945-7587**  
Photovoltaics • Microhydro • Windpower • Water Pumping  
Consultation • Site Survey • Installations  
CA Electrical Lic #613554



Authorized Distributor



**Trace 4,000 watt Sinewave Inverter**  
Equally at home on or off the grid!  
Utility intertie and battery — the best of both worlds!  
Sophisticated, high output battery charger  
Clean and quiet sinewave power  
Over 90% efficiency and low idle power  
Now available optimized for alkaline batteries.



**Sun Spot™ Solar Oven**  
\* Lightweight — 1¼ pounds!  
\* Portable — Backpackable!  
\* Expandable cooking chamber!  
\* Heats to 350°F!  
**\$30 shipped free in USA**  
CA Residents please add 7.25% tax.

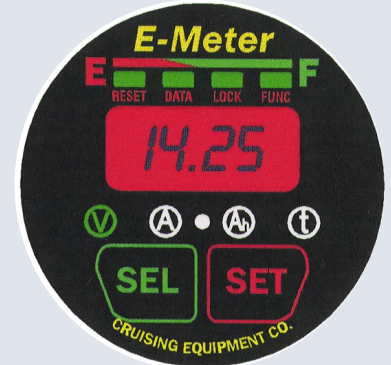

### Graphic and Digital Displays

- \* Digital Volt, Amp, Amp/Hr Meters
- \* Battery Temperature Compensation
- \* Monitors Battery Systems 12 to 500VDC
- \* Discharge Time Remaining Display for EVs
- \* Perfect for EVs, RVs, Marine, and AE Systems
- \* Stores Discharge Data, Efficiency, More!
- \* User Customizable Setup
- \* Price INCLUDES 500A Shunt
- Options
- \* RS-232 output for computer interface
- \* Remote relay output based on A/hrs
- \* Remote temperature sensor

**In Stock — Call!**



- **Photovoltaics** — Solarex - Siemens - BP - Midway Labs
- **High-Quality Batteries** — Trojan - US Battery
- **Power Inverters** — Trace Engineering - PowerStar - Exeltech - AC Genius
- **Instrumentation** — Cruising Equipment - Fluke - Wavetek
- **Charge Controllers** — Heliotrope General - SunAmp - Trace
- **Trackers & PV Mounts** — WATTSUN - Zomeworks - Direct Power
- **Microhydro Electric Powerplants** — Harris Hydro - Lil Otto Hydroworks! - ES&D
- **Pumps** — Solar Slowpump™ - Flowlight - Solarjack - SHURflo - A.Y. McDonald
- **Water Heaters** — Myson - Aquastar
- **Efficient Lighting** — Phillips - Osram
- Sun Frost • APT • Heinemann • Cutler & Hammer • Square D Products



OptaPhone+  
OptaPhone STAR

SOLAREX

SIEMENS  
ProCharger 4JF



PowerStar  
PRODUCTS - INCORPORATED

Trojan  
The Better Battery

SUN FROST

EXELTECH

### •••• DEALER/INSTALLERS! ••••

Anyone can sell you parts. We use and install the components we sell. We KNOW how they work and offer technical support, system design assistance, prompt shipment, fair pricing, and NO BULL. Electrical competence required. Find out why Electron Connection's dealers are prospering!  
Write today for your dealer application.



## Electron Connection

POB 203, Hornbrook, CA 96044 USA

VOICE • FAX 916-475-3401

Internet: [econnect@snowcrest.net](mailto:econnect@snowcrest.net)



# HOME POWER

THE HANDS-ON JOURNAL OF HOME-MADE POWER

ISSUE #49

October / November 1995

\$4.75 U.S.

\$6.60 CAN.

Display until December 1

